

Service  
Service  
Service

MCP9350i



# Service Manual

<b>Contents</b>		<b>Page</b>	<b>Contents</b>		<b>Page</b>
1.	About this Manual	2	9.	Software Update and Repair	16
2.	Safety Instructions, Warnings and Notes	3	10.	PC Doctor Diagnostic Tool	20
3.	System Overview	4	11.	Hardware Tests	22
4.	Technical Reference	5	12.	Hardware Repair	38
5.	Required Equipment List	10	13.	Software Re-installation	64
6.	Diagnosis and Repair Flowchart	11	14.	End Test	65
7.	Installation and Initial Checks	12	15.	Parts Information	66
8.	Troubleshooting - Start-up Failure	15			

©Copyright 2005 Philips Consumer Electronics B.V. Eindhoven, The Netherlands.  
All rights reserved. No part of this publication may be reproduced, stored in a retrieval system or transmitted, in any form or by any means, electronic, mechanical, photocopying, or otherwise without prior permission of Philips.



**PHILIPS**

# 1. About this Manual

## 1.1. Content of this Manual

**Note:** The MCP9350i will be serviced on a modular level only. Faulty modules will be identified and replaced. Detailed circuit diagrams and technical information on a component level are therefore not provided in this document.

### 1.1.1. What is included in this Manual

- Safety Information
- System Overview
- Basic System Block Diagrams
- Parts / Module Identification
- Module Functional Descriptions
- Basic Module Technical Descriptions
- Basic Measuring Point Information
- Basic Fault Finding Strategy
- Module Removal & Replacement Procedures
- Functionality Testing Procedures
- End Test Sequence / Checklist
- Parts List / 12NC Numbers

## 1.2. Additional Documentation

The following documentation is supplied by Philips and can be used for further reference.

- MCP9350i Quick Install Guide
- MCP9350i Use Cases
- RC4370 Remote Control User Manual

## 2. Safety Instructions, Warnings and Notes

### 2.1. Safety Instructions

#### 2.1.1. ESD Protection



All ICs and many other semi-conductors are susceptible to electrostatic discharges (ESD). Careless handling during repair can reduce life drastically. When repairing, make sure that you are connected with the same potential as the mass of the set via a wrist wrap with resistance. Keep components and tools also at this potential.

## 3. System Overview

### 3.1. Technical Specification

#### System - General

CPU: 3.0 GHz P4 (630)  
 Memory: 512 MB  
 HDD: 250 GB SATA

#### Optical disc recording:

DVD: +RW, +R, -R, -RW, +R DL  
 CD: -R, -RW

Wireless LAN: IEEE802.11 b/g

#### Software installed:

Windows® XP Media Center Edition  
 LikeMusic  
 Norton Internet Suite  
 Cyberlink: Make DVD, CaptureDV, PowerDVD  
 Picture improvement: Trimension MCE  
 Philips Media Manager

#### Picture Improvement algorithms:

**Digital Natural Motion**  
 Motion adaptive de-interlacing Film mode detector

Tuner card: NVIDIA

TV system: PAL/SECAM

#### Connection front

Card reader: MS/MS pro (Memory Stick)  
 CF I/II Microdrive (Compact Flash)  
 Smart Media  
 MMC/SD (Multi Media Card/Secure Digital)

USB 2x USB 2.0

IEEE1394 1x 4 pins (i.LINK)

Microphone 6.3 mm jack

Headphone 6.3 mm jack

#### Connection rear

Video outputs: DVI-D single link  
 VGA  
 S-video (Y/C)  
 SCART (CVBS + RGB)

Video Inputs: 2 x S-video (Y/C)  
 2 x CVBS

Audio outputs: 2x stereo Chinch L/R  
 Optical digital out  
 Coax digital out

Audio inputs: 2x stereo Chinch L/R

Ethernet: 1x (100 Mb)

Modem (built in): 1x RJ45

USB: 2x USB 2.0

IEEE1394: 2x 6 pins

IR blaster: 2x to support up to 3 IR blaster eyes

Others: TV in

FM radio in

#### Accessories

DVI to DVI cable

DVI to HDMI cable

SCART cable

Digital audio coax cable

Power cable

FM antenna cable

S-video (Y/C)

Stereo audio cable

Ethernet cable

Telephone cable

2x IR blaster with 1 IR transmitter

TV antenna splitter

Antenna cable 10 cm

Antenna cable 1 m

SCART adapter (SCART to CVBS/S-video (Y/C))

Audio L/R Chinch

Universal remote control with batteries

Wireless keyboard with batteries

# 4. Technical Reference

## 4.1. System Block Diagram

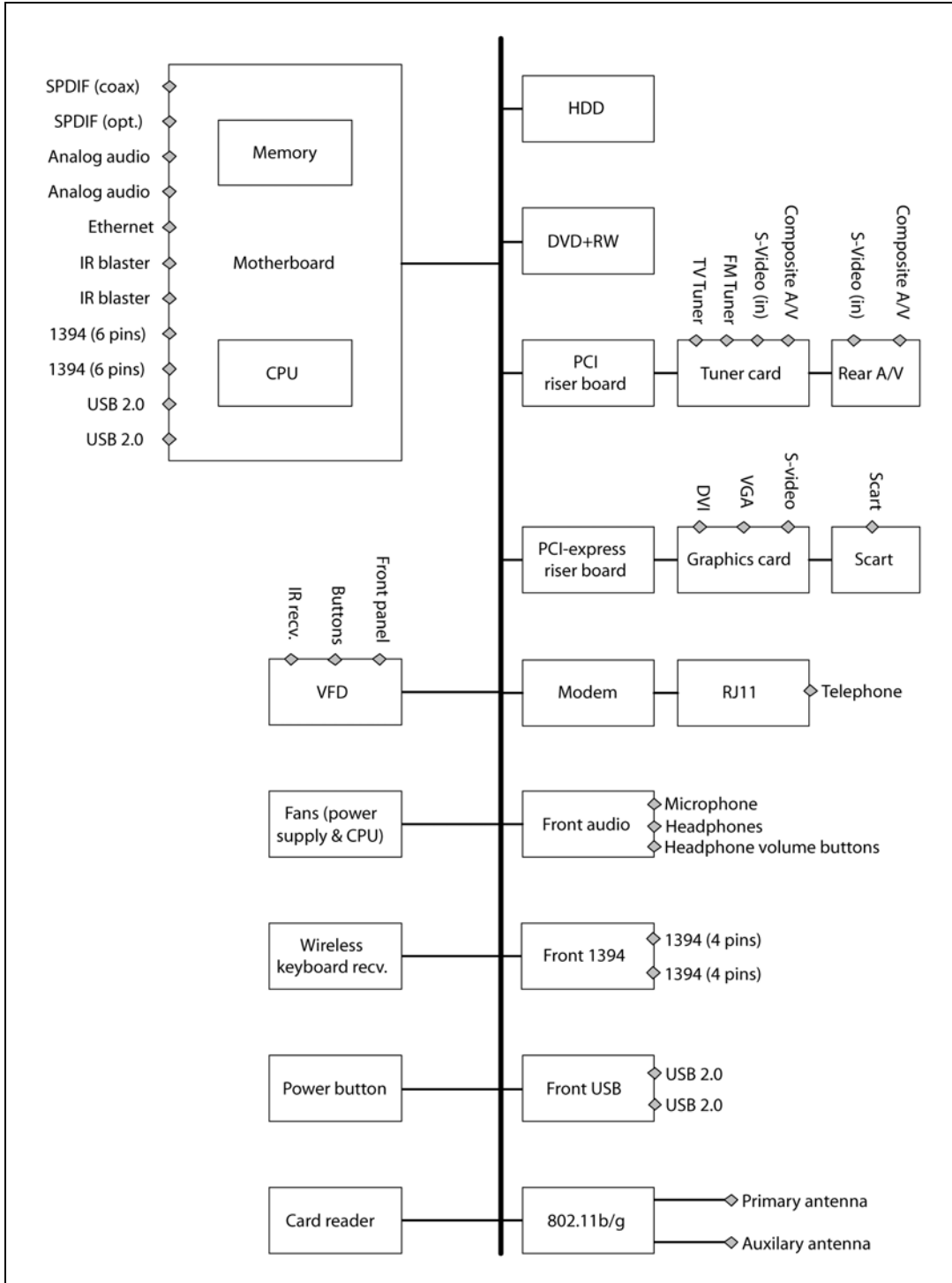

Figure 4.1-1

### 4.2. System Cable Definition

#### 4.2.1. System Cable Schematic

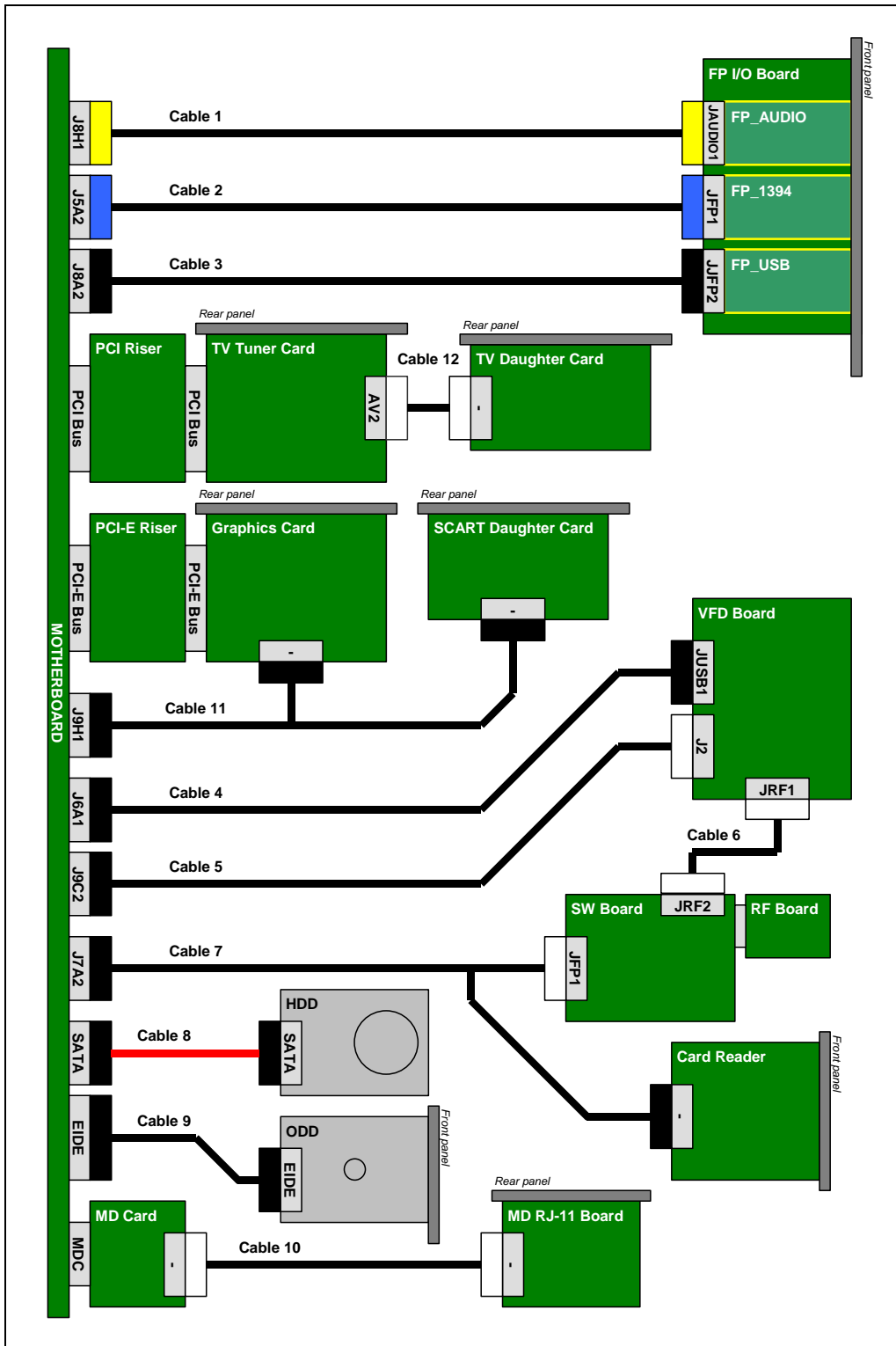

Figure 4.2-1

## 4.2.2. System Cable Definition Table

Cable Number	Cable Name	Start	End(s)
1	FP_AUDIO_CABLE	MB J8H1	FP BOARD JAUDIO1
2	FP_1394_CABLE	MB J5A2	FP BOARD JFP1
3	FP_USB_CABLE	MB J8A2	FP BOARD JFP2
4	VFD_USB_CABLE	MB J6A1	VFD Board JUSB1
5	IR_BLASTER_INTERNAL_CABLE	MB J9C2	VFD BOARD J2
6	SW_RF_CABLE	VFD Board JRF1	SW BOARD JRF2
7	V-TYPE_CABLE	MB J7A2	(1) SW BOARD JFP1 (2) CARD READER
8	SATA_HDD_CABLE	MB J7F1	HDD
9	ATA33_ODD_CABLE	MB EIDE	ODD
10	MD_CABLE	MB MD CARD	MD RJ-11 CONNECTOR BOARD
11	ADD2_SCART_CABLE	MB J9H1	(1) ADD2 SCART DAUGHTER CARD (2) GRAPHICS CARD (ADD2 BOARD)
12	A/V_1x10_CABLE	TV tuner AV2	TV daughter card

### 4.3. PSU Cables and Connectors Definition

#### 4.3.1. PSU Cable Schematic

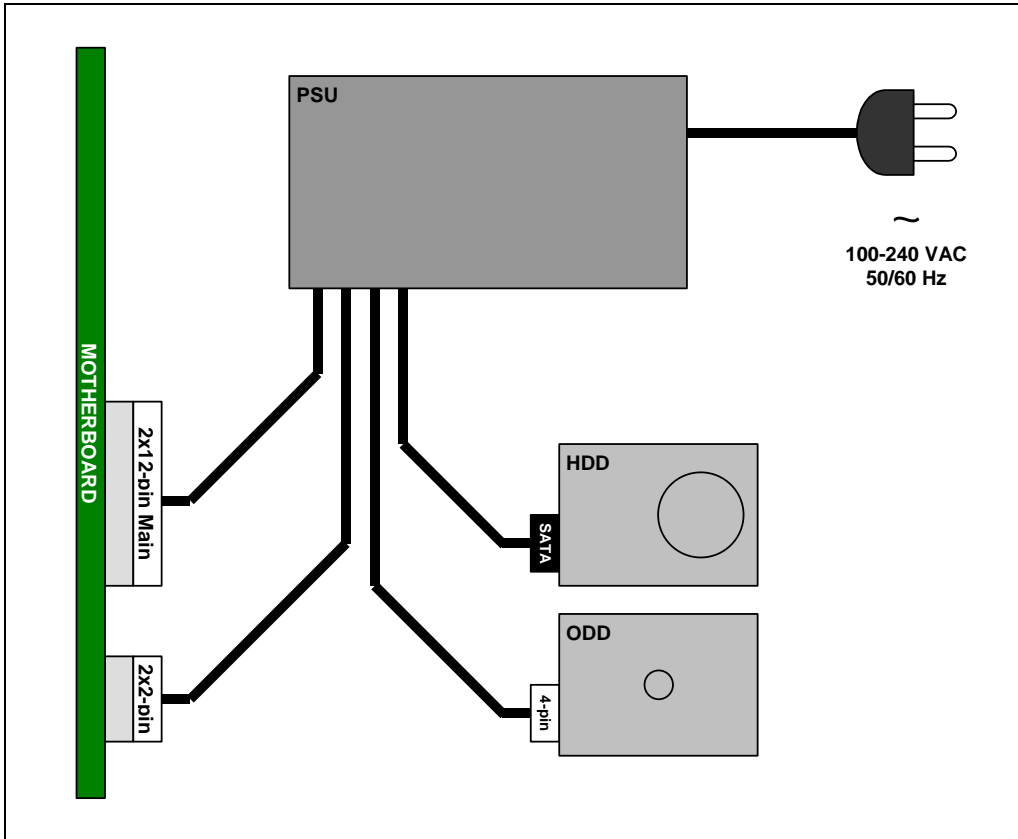
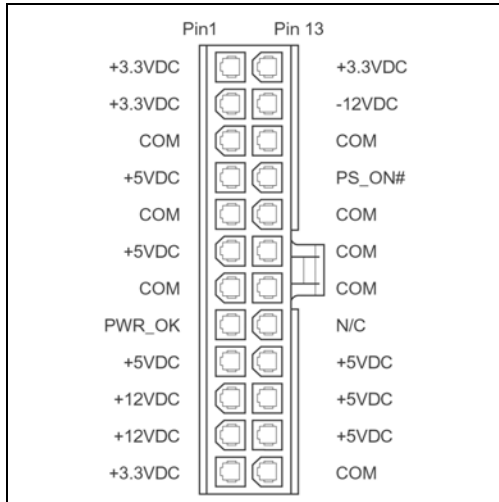

Figure 4.3-1



4.3.2. PSU Connector Pin Definition



Main Power Connector, 2x12-pin

Figure 4.3-2

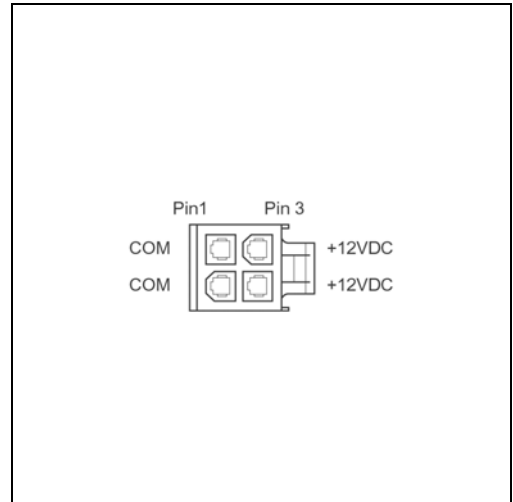

+12V Power Connector, 2x2-pin

Figure 4.3-3

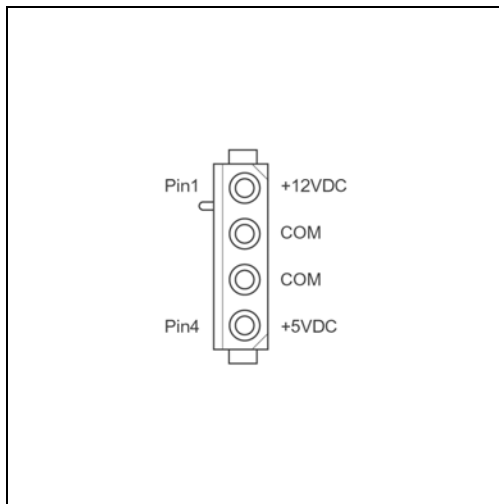

Peripheral Power Connector, 4-pin

Figure 4.3-4

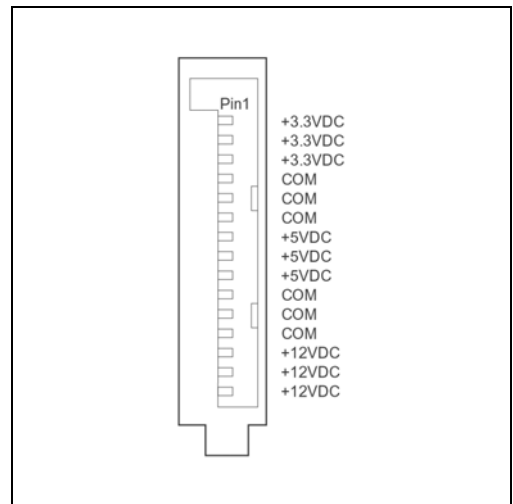

Serial ATA (SATA) Power Connector

Figure 4.3-5

## 5. Required Equipment List

### Equipment & Facilities

- Repair kit
  - Working samples of all modules of the MCP9350i
  - Wireless keyboard with integrated trackball
  - Remote control (MediaCenter version)
- PC Monitor with VGA and DVI input
- TV with SCART and S-Video input
- USB keyboard
- Stereo Headphones (with 6.3 mm Jack Plug)
- Microphone (with 6.3 mm Jack Plug)
- IEEE 1394 4-pin device (example: digital video camcorder)
- IEEE 1394 6-pin device (example: external hard disk)
- USB device (examples: USB memory stick; USB mouse)
- External audio amplifier with the following connections:
  - audio L/R cinch inputs (x2)
  - coaxial SPDIF input
  - optical SPDIF input
- Wireless (IEEE 802.11 b/g) access point and router with Ethernet LAN ports
- S-video signal source (examples: DVD player; video camcorder)
- Composite video signal source (examples: DVD player; video camcorder)
- RF TV signal source (examples: external TV antenna; cable TV connection; VCR)
- RF Radio signal source (examples: external radio antenna; cable connection)
- Analogue telephone line

### Cables

- VGA cable
- DVI cable
- SCART cable
- S-Video cable
- IEEE 1394 4-pin cable
- IEEE 1394 6-pin cable
- 2x Audio L/R Chinch cables
- Digital audio coax cable
- Digital audio optical cable
- Ethernet cable (RJ45, CAT5)
- Telephone cable (RJ11)
- TV and Radio RF coax cable

### Software Tools

- Recovery DVD
- PC Doctor – Service Edition (CD and USB license)
- Test CD with latest BIOS, drivers, applications and PC Doctor test scripts

### Memory Cards / Media

- Compact Flash (CF)
- Smart Media (SM)
- Secure Digital (SD)
- MultiMedia Card (MMC)
- Memory stick (MS)
- Audio CD
- Video DVD
- CD R / RW
- DVD+R / RW

## 6. Diagnosis and Repair Flowchart

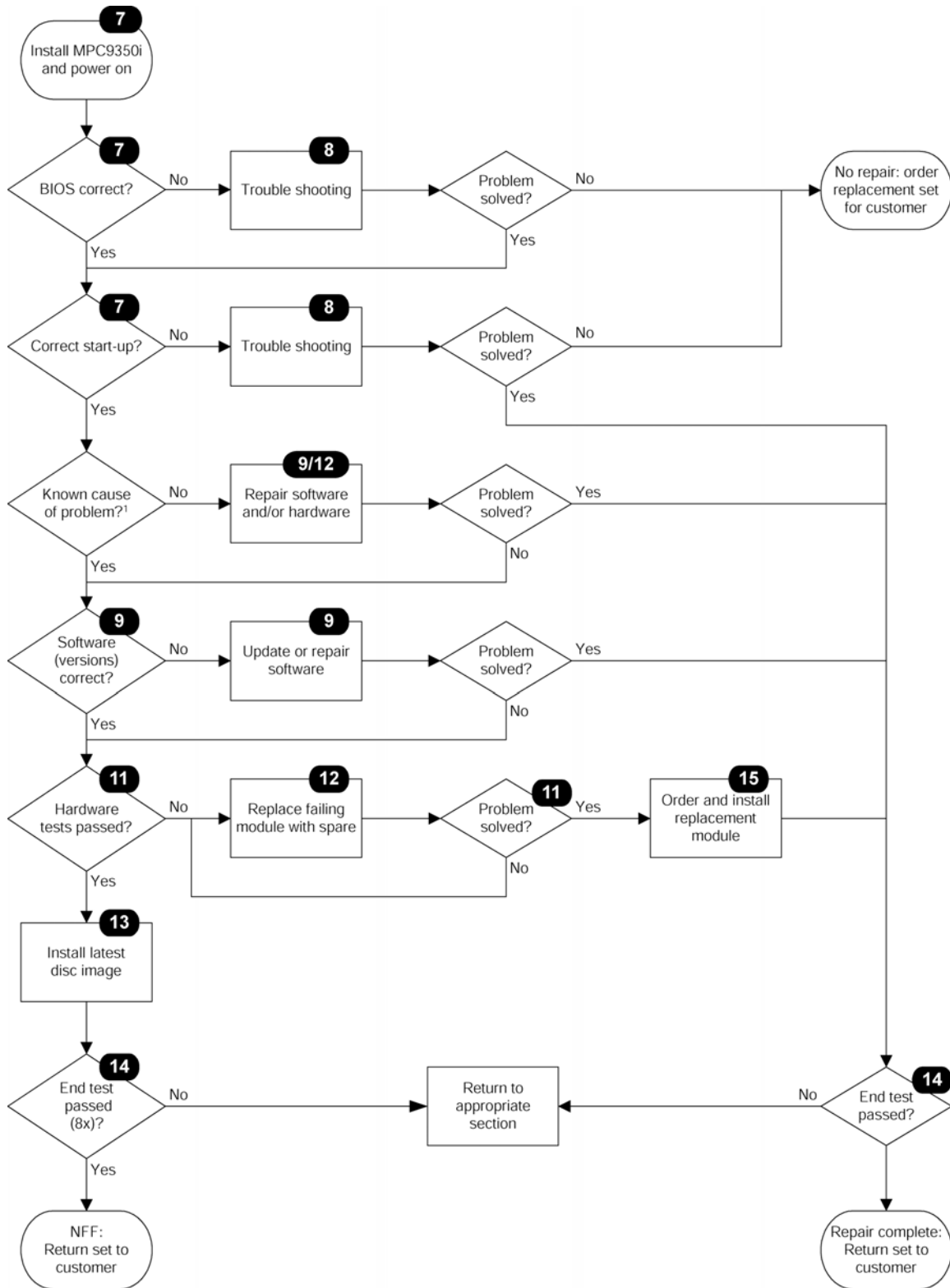

<sup>1</sup> Call center or customer provided a problem report that identifies a clear problem

Figure 6-1

## 7. Installation and Initial Checks

### 7.1. Installation

1. Connect the MCP9350i to a monitor, using either the DVI or the VGA connector.
2. Insert the power cord (both 110V or 230V are supported). The LED on the Standby-On button should light-up yellow.
3. Connect a USB keyboard to one of the front USB ports.

### 7.2. BIOS Check

#### 7.2.1. Test Procedure

1. Install the MCP9350i. See paragraph 7.1.
2. Press the Standby-On button. The LED on the Standby-On button will turn-off and the MCP9350i should begin to start up.
3. During the early part of the start-up process press the 'F2' key on the keyboard to enter the BIOS setup.
4. On the BIOS setup main screen check the installed memory size. See table below.

Total memory size	512 MB
-------------------	--------

5. Check the system manufacturer information. (BIOS menu select: **Main > Additional system information**). See table below.

System information > manufacturer	"Tatung co."
Desktop board information > manufacturer	Intel Corporation
Chassis Information > Manufacturer	Philips MCPC1001

6. Check the BIOS version. (BIOS menu select: **Main > BIOS version**). See table below.

Software module	Release version
System BIOS	SU94510J.86A.0048

7. Check that the HDD and the optical drive have been detected by the BIOS. (BIOS menu select: **Advanced > Drive Configuration**). See table below.

Drive	Type
HDD (primary supplier)	Western Digital WD????JS-55M-250.0GB
Optical Drive	Philips DVDR1628 – ATAPI

8. Check the function of the temperature sensors. Confirm that the temperatures have reasonable values, between 0 C and 128 C. (BIOS menu select: **Advanced > Hardware Monitoring**). See table below.

Temperature Sensor	Possible value (allow for a wide variation)
Processor 1	63 C
Front internal	31 C
Rear internal	25 C
Remote 1	23 C
Remote 2	21 C

9. Check the fan speeds. (BIOS menu select: **Advanced > Hardware Monitoring**). See table below.

Fan	Speed (allow for a wide variation)
Processor 1 fan	900 – 1400 RPM
Rear fan	1000 RPM

10. Check the power values. (BIOS menu select: **Advanced > Hardware Monitoring**). See table below.

Power	Center value (allow for a $\pm 5\%$ variation)
V 12.0	+12.0 V ( $\pm 0.6$ V)
V 5.0	+5.0 V ( $\pm 0.25$ V)
V 3.3	+ 3.3 V ( $\pm 0.165$ V)
V 1.5	+1.5 V ( $\pm 0.075$ V)
V ccp	+ 1.28 V ( $\pm 0.064$ V)

11. Exit the BIOS setup screen without saving changes. (BIOS menu select: **Exit > Exit discarding changes**).

The MCP9350i will now continue to start-up. Perform the start-up sequence check, see paragraph 7.3.

### 7.2.2. Fail Procedure

Perform Troubleshooting procedure. See paragraph 8.

### 7.3. Start-up Sequence Check

#### 7.3.1. Test Procedure

1. Power on the MCP9350i.
2. Watch the boot-up sequence for error messages.
3. After a short time the Windows Media Center main window, or the Windows XP desktop (possibly adapted by the user), will be shown on-screen.



Figure 7.3-1: Media Center main window (English version)



Figure 7.3-2: Windows XP desktop (English version)

#### 7.3.2. Fail Procedure

Perform Troubleshooting procedure. See paragraph 8.

## 8. Troubleshooting - Start-up Failure

### 8.1. Problems in BIOS

This section lists potential BIOS problems together with recommended corrective actions.

- Incorrect BIOS version
    - Update the BIOS. See paragraph 9.2.
  - Drive(s) not detected
    - Replace the drive cable(s).
    - Replace the drive(s). See paragraph 12.3 or 12.4.
- Note:** Any service to non-standard drives must be treated as an out-of-warranty service call.
- Incorrect temperature
    - Check that the thermistor plugs on the motherboard are correctly inserted. See paragraph 12.16.9.
    - Replace the motherboard. See paragraph 12.16.9.
  - Incorrect fan speeds (with correct temperature)
    - Re-insert fan cables.
    - Replace fan. See paragraph 12.15.5.
    - Replace motherboard. See paragraph 12.16.9.
  - Incorrect power
    - See paragraph 8.2.
  - No or insufficient memory (512 MB expected)
    - Re-insert the memory modules. See paragraph 12.16.7.
    - Remove the memory modules and insert in the other connector bank (black DIMM connectors on the motherboard).
    - Replace the memory modules. See paragraph 12.16.7.
    - Replace the motherboard. See paragraph 12.16.9.
  - Chassis manufacturer is not '**Philips MCPC1001**'
    - Update the BIOS. See paragraph 9.2.

### 8.2. No or Incorrect Power

1. Re-insert the PSU cables.
2. Disconnect the PSU cables and measure the voltages. See paragraph 4.3.2.
  - If the values are incorrect replace the PSU. See paragraph 12.14.1.
3. Replace the SW Board. See paragraph 12.10.
4. Reinsert CPU or replace the CPU. See paragraph 12.16.5.
5. Replace the motherboard. See paragraph 12.16.9.

### 8.3. No Video

1. Make sure that a working monitor is connected and in the correct mode (VGA or DVI).
2. Remove the memory from the motherboard, (see paragraph 12.16.7), and reboot. If there is a beeping sound, replace the memory.
3. Re-insert the memory. See paragraph 12.16.7.
4. If there is still no video, replace the graphics card. See paragraph 12.6.
5. Replace the motherboard. See paragraph 12.16.9.

### 8.4. Operating System Not Found

1. Reboot the MCP9350i and enter the BIOS menu by pressing 'F2'. Confirm that the HDD is detected.
2. Replace the SATA cable.
3. Replace the HDD. See paragraph 12.3.
4. Re-insert the memory modules. See paragraph 12.16.7.
5. Remove the memory modules and insert in the other connector bank (black DIMM connectors on the motherboard).
6. Replace the memory modules. See paragraph 12.16.7.
7. Replace the motherboard. See paragraph 12.16.9.

### 8.5. No Repair

If none of the above recommendations have solved the problem and the set cannot be repaired, it must be sent for further analysis to Philips. If the incident happened within the warranty period, the customer shall be provided with a new set. Please initiate a 'non-policy replacement' procedure with Euroservice.

## 9. Software Update and Repair

This section describes how to update and 'repair' the software on the MCP9350i without affecting the customer's data.

### 9.1. Software Update and Repair Flowchart

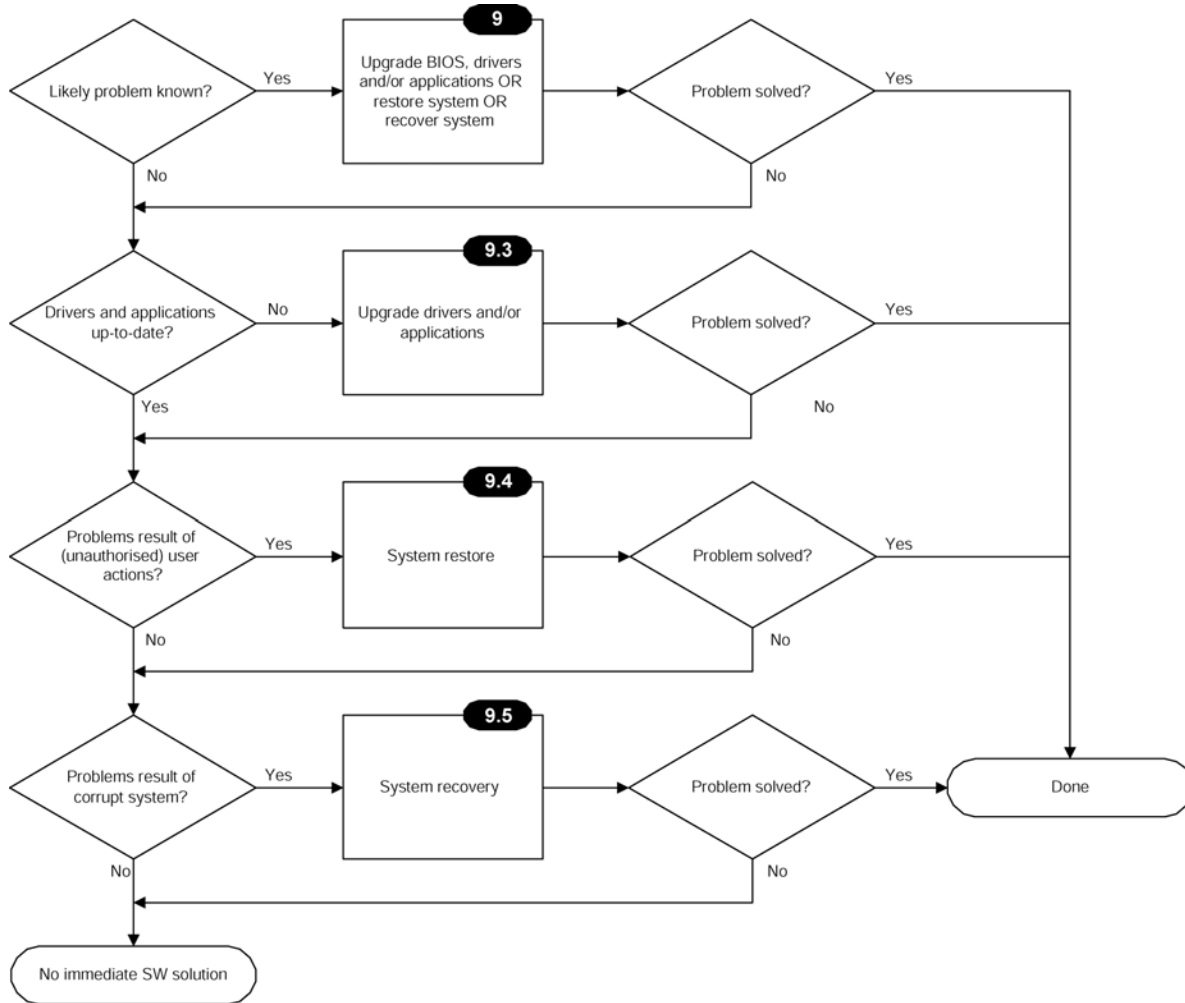



## 9.2. Update BIOS

Update the BIOS after installing a new motherboard, or when the MCP9350i is programmed with an older version of the BIOS.

1. Insert the bootable disc with the latest BIOS version.
2. Restart the MCP9350i.
3. Follow the on-screen instructions.

## 9.3. Update Drivers and Software

The table below lists the drivers and software applications that are installed on the MCP9350i and that could theoretically have been altered by the customer in such a way that the system stopped performing correctly.

Software module	Release version
Microsoft MediaCenter Edition	MCE Version 2005 SP2, v.2161
Intel chipset software installation utility	7.0.0.1025
Intel 945G Graphics	PV14.17.1.4399 (ver. 6.14.10.4399)
Intel 82562EZ or 82562EX (10/100) LAN controller	8.0.19.0
Sigmatel Audio Drivers	v012_4641_EPC_W
C-com / Smartlink Azalia modem	7.23.00.00
Lite-On Atheros WLAN	4.1.2.57
Tatung Front Panel Manager VFD w/ button board	1.1_PV
Tatung VFD Firmware	1.10_PV
ODD FW	P1.0
Nvidia (TV Tuner)	Nvidia_5.9.4.86
LikeMusic	Like Music GM
CyberLink AP (Power DVD, Make DVD, Capture DV)	Cyberlink GM 3.0
Philips Media Manager Program	PMM_windows_3_2_1_0004

In case of a problem with the software, the normal procedure is to recover the system with the latest disc image (as provided by Philips). Repair or upgrade of the software is on the repair technician's own risk.

## 9.4. System Restore

1. In Windows XP select: **Start > All programs > Accessories > System Tools > System Restore.**

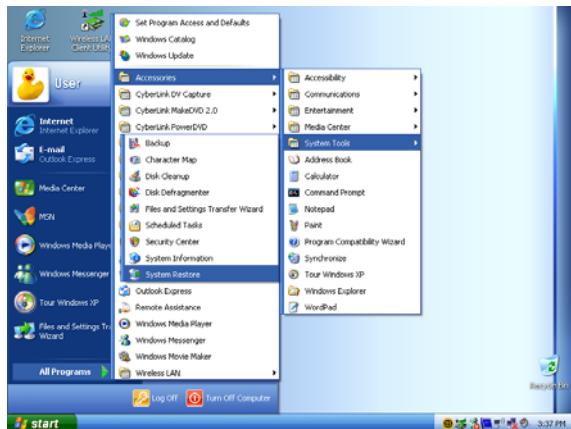

Figure 9.4-1

2. Select the 'restore my system to an earlier time' option.

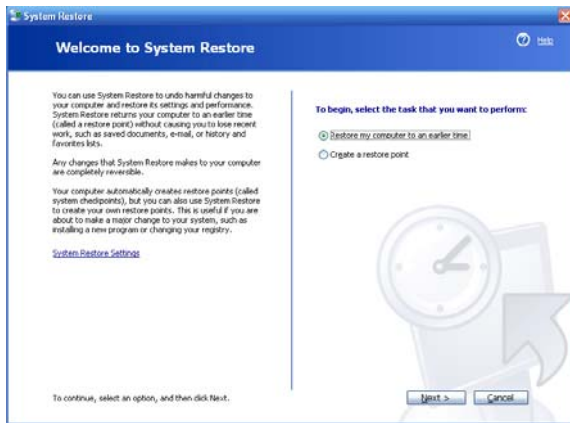

Figure 9.4-2

3. Select a date in time before the problems were first seen.

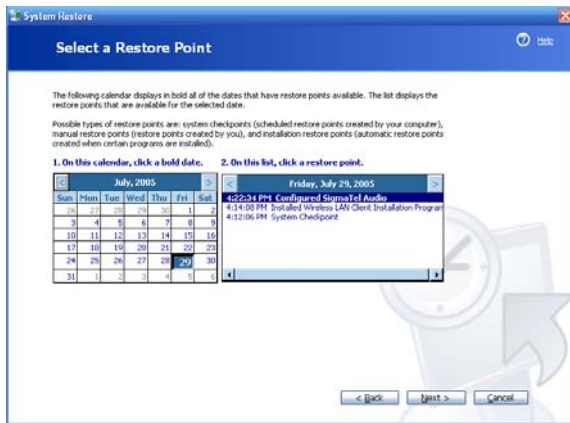

Figure 9.4-3

4. Carefully read the instruction and continue.

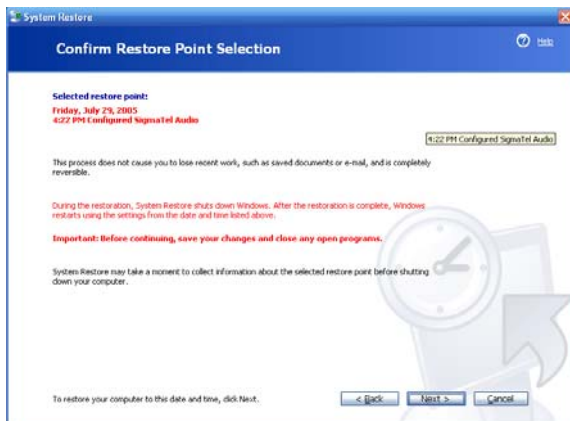

Figure 9.4-4

## 9.5. System Recovery

A system restore is used to return the set to its original software configuration. If a later software built is available, this built should be installed on the system instead (see Chapter 13 – Software Re-installation)

1. In Windows XP select: **Start > All programs > System Recovery > System Recovery**. (Alternatively, press the **F11** key during boot sequence).

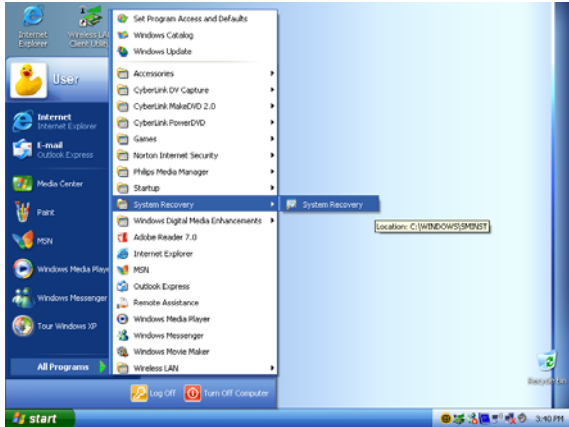

Figure 9.5-1

2. Follow the on-screen instructions to perform a system recovery without performing a format, (operations from this point are carried out in DOS mode).

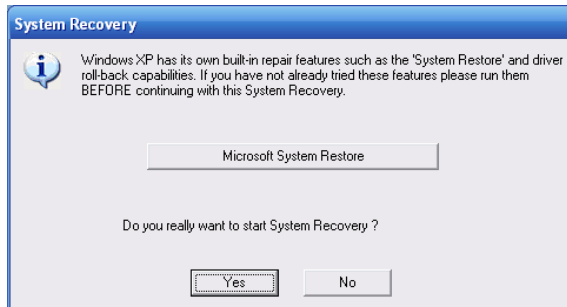

Figure 9.5-2

## 10. PC Doctor Diagnostic Tool

### 10.1. PC Doctor Introduction

PC Doctor is a software based test tool that is used to verify the correct functioning of different modules.

### 10.2. Running PC Doctor

1. Insert the 'PC Doctor' USB dongle in one of the USB slots on the back of the MCP9350i.
2. Insert the PC Doctor disc.
3. If this is the first time that the dongle is used, install the driver for the USB dongle from the PC Doctor disc.
4. Start PC Doctor in the '**Quick Install and Run**' mode (otherwise certain tests will not be enabled). See Figure 10.2-1.



Figure 10.2-1

5. PC Doctor will now run. Select the '**diagnostics**' option. You are now ready to run one of the tests by selecting one of the icons. See Figure 10.2-2.

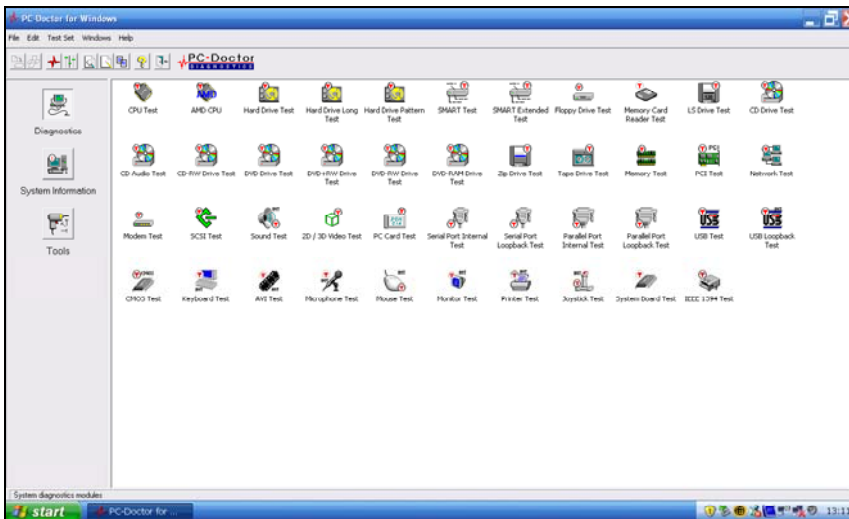

Figure 10.2-2

**Note:** It is recommended that test sequences be run using the PC Doctor batch files provided by Philips. See paragraph 10.3.

**Note:** More information on the type and sequence of tests can be found in paragraph 11.2.

### 10.3. PC Doctor Batch Tests

Sequences of PC Doctor tests can be pre-programmed to run in batches. There are two pre-programmed test batch files provided by Philips on the Test CD. These are identified as 'Automatic' tests and 'Interactive' tests.

#### Automatic tests

These are tests that run fully automatic, without any user interaction. This test sequence takes approximately 15 minutes to complete.

1. Copy the test script '**Automatic.PCB**' from the test CD to the HDD of the MCP9350i.
2. Insert a DVD+RW disc in the optical drive.
3. Insert memory cards in all four slots of the memory card reader.
4. Connect the set with the network using an Ethernet cable.
5. Insert the telephone line in the modem connector.
6. Insert the USB flash drive containing the batch files.
7. In the PC Doctor menu select: **Test Set > Custom Test Settings**.
8. Open the automated test batch file '**Automatic.PCB**' from the HDD and start the test sequence.
9. Remove the test script from the HDD after the test sequence has finished.

#### Interactive tests

These tests require some action of the user (listening to sound, pushing buttons at the keyboard, etc.). This test sequence takes approximately 5 minutes to complete.

1. Copy the test script '**Interactive.PCB**' from the test CD to the HDD of the MCP9350i.
2. Insert the USB flash drive containing the batch files.
3. In the PC Doctor menu select: **Test Set > Custom Test Settings**.
4. Open the interactive test batch file '**Interactive.PCB**' from the HDD and start the test sequence.
5. Follow the on-screen instructions.
6. Remove the test script from the HDD after the test sequence has finished.

# 11. Hardware Tests

## 11.1. Introduction

The purpose of the hardware tests is to guarantee the correct functioning of all hardware modules. There are three cases:

1. The cause of the hardware problem is known. Run the appropriate test to confirm that the cause of the problem is correct. Swap the failing module with one from the 'repair kit'. Run the test again. For swapping: swap the cheapest component first (e.g. cables, riser boards), then the modules and finally the motherboard.
2. The cause of the problem is not known. Start with the first test (see below) and continue until one of the tests fails. Then swap the failing module, etc.
3. None of the tests identifies a failing module. If the technician suspects that the problem is not covered by the tests, he can create his own test. Otherwise, the product is marked as 'NFF'. When the new test finds a problem, the technician has to inform Philips about this so it can be used to improve the test process.

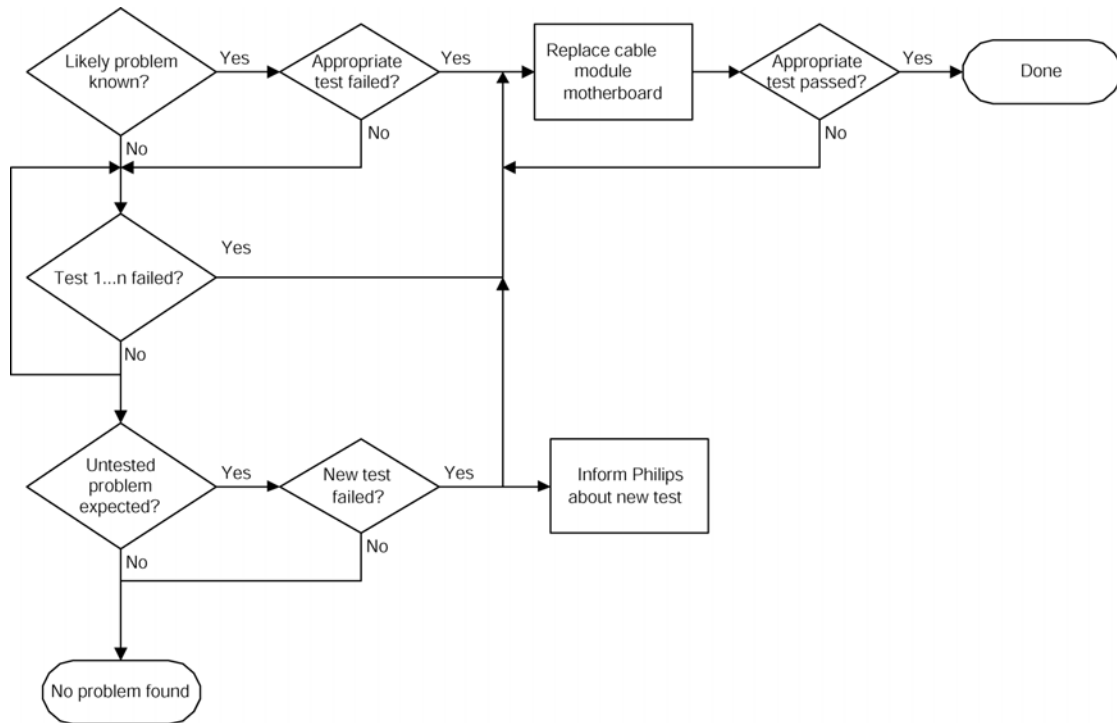

## 11.2. Test Sequence

#	Test Method (paragraph)	Module	Test Type	<input checked="" type="checkbox"/> Checked
1	7.2	BIOS check	Manual	<input type="checkbox"/>
2	7.3	Start-Up sequence	Manual	<input type="checkbox"/>
3	11.3	Fan speed	Manual	<input type="checkbox"/>
4	11.4	CPU	Automatic	<input type="checkbox"/>
5	11.5	HDD (Hard disk drive)	Automatic	<input type="checkbox"/>
6	11.6	Memory card reader	Automatic	<input type="checkbox"/>
7	11.7	ODD (Optical disk drive)	Automatic	<input type="checkbox"/>
8	11.8	Memory	Automatic	<input type="checkbox"/>
9	11.9	PCI cards	Automatic	<input type="checkbox"/>
10	11.10	Ethernet connection	Automatic	<input type="checkbox"/>
11	11.11	Modem	Automatic	<input type="checkbox"/>
12	11.12	Graphics card	Automatic	<input type="checkbox"/>
13	11.13	USB controllers	Automatic	<input type="checkbox"/>
14	11.14	CMOS	Automatic	<input type="checkbox"/>
15	11.15	Motherboard	Automatic	<input type="checkbox"/>
16	11.16	IEEE 1394 controller	Automatic	<input type="checkbox"/>
17	11.17	Rear Panel Audio Output Connectors	Interactive	<input type="checkbox"/>
18	11.18	Wireless keyboard (and receiver)	Interactive	<input type="checkbox"/>
19	11.19	Microphone, headphones and headphones volume control	Interactive	<input type="checkbox"/>
20	11.20	Wireless network connection	Manual	<input type="checkbox"/>
21	11.21	USB connectors	Manual	<input type="checkbox"/>
22	11.22	IEEE 1394 connectors	Manual	<input type="checkbox"/>
23	11.23	Video outputs	Manual	<input type="checkbox"/>
24	11.24	FM Tuner	Manual	<input type="checkbox"/>
25	11.25	TV Tuner Card and Audio / Video Inputs	Manual	<input type="checkbox"/>
26	11.26	Front display and buttons	Manual	<input type="checkbox"/>
27	11.27	Remote control and infrared receiver	Manual	<input type="checkbox"/>
28	11.28	IR blaster	Manual	<input type="checkbox"/>

### 11.3. System Fans

#### 11.3.1. Required Equipment

None.

#### 11.3.2. Test Procedure

At first start-up, the PSU and CPU fans will start at the highest speed. After a couple of seconds, the fans must switch to a slower speed.

**Note:** When the system has already been running, the fans might start at the lower speed.

#### 11.3.3. Fail Procedure

- Replace the PSU fan. See paragraph 12.14.3.
- Replace the CPU fan. See paragraph 12.15.5.
- Replace the motherboard. See paragraph 12.16.9.

### 11.4. CPU

#### 11.4.1. Required Equipment

PC Doctor CD & USB dongle

#### 11.4.2. Test Procedure

In PC Doctor: Run the CPU test.

#### 11.4.3. Fail Procedure

Replace the CPU. See paragraph 12.16.5.

### 11.5. HDD (Hard disk drive)

#### 11.5.1. Required Equipment

PC Doctor CD & USB dongle

#### 11.5.2. Test Procedure

In PC Doctor: Run the 'SMART' test.

#### 11.5.3. Fail Procedure

- Replace the SATA cable.
- Replace the HDD. See paragraph 12.3.
  - Make sure that the latest software image is installed on the replacement HDD. See paragraph 13.

### 11.6. Card Reader

#### 11.6.1. Required Equipment

- PC Doctor CD & USB dongle
- Compact Flash (CF) card
- Smart Media (SM) card
- Secure Digital (SD) card
- Memory Stick (MS)

#### 11.6.2. Test Procedure

1. Insert the memory cards into the appropriate slots of the card reader.
2. In PC Doctor: Run the card reader test.

#### 11.6.3. Fail Procedure

- Replace the V-Type cable.
- Replace the card reader board. See paragraph 12.11.3.
- Replace the motherboard. See paragraph 12.16.9.



## 11.7. ODD

### 11.7.1. Required Equipment

- PC Doctor CD & USB dongle
- DVD+RW disc

### 11.7.2. Test Procedure

1. Insert the DVD+RW disc into the ODD.
2. In PC Doctor: Run the DVD+RW test.

### 11.7.3. Fail Procedure

- Replace the ATA33 cable.
- Replace the ODD. See paragraph 12.4.

## 11.8. Memory

### 11.8.1. Required Equipment

PC Doctor CD & USB dongle

### 11.8.2. Test Procedure

In PC Doctor: Run the memory test.

### 11.8.3. Fail Procedure

- Remove the memory modules and insert in the other connector bank (black DIMM connectors on the motherboard).
- Replace the defective DIMM. See paragraph 12.16.7.

## 11.9. PCI Cards

### 11.9.1. Required Equipment

PC Doctor CD & USB dongle

### 11.9.2. Test Procedure

In PC Doctor: Run the PCI test.

### 11.9.3. Fail Procedure

- Replace the Riser Card associated with the failing PCI card. See paragraph 12.6 or 12.7.
- Replace the failing PCI card. See paragraph 12.6 or 12.7.

## 11.10. Ethernet

### 11.10.1. Required Equipment

- PC Doctor CD & USB dongle
- Wireless router/access point with Ethernet ports
- Ethernet cable

### 11.10.2. Test Procedure

1. Connect the Media Centre PC with the router using the Ethernet cable.
2. In PC Doctor: Run the network test.

### 11.10.3. Fail Procedure

Replace the motherboard. See paragraph 12.16.9.

## 11.11. Modem

### 11.11.1. Required Equipment

- PC Doctor CD & USB dongle
- Active telephone line
- Telephone cable

### 11.11.2. Test Procedure

1. Connect the Media Center PC to the telephone line using the telephone cable.
2. In PC Doctor: Run the modem test.

### 11.11.3. Fail Procedure

- Replace the modem cable.
- Replace the RJ11 connector board. See paragraph 12.9.5.
- Replace the modem board. See paragraph 12.9.1.
- Replace the motherboard. See paragraph 12.16.9.

## 11.12. Graphics Card

### 11.12.1. Required Equipment

PC Doctor CD & USB dongle

### 11.12.2. Test Procedure

In PC Doctor: Run the 2d/3d test

### 11.12.3. Fail Procedure

- Replace PCI-express riser board. See paragraph 12.6.
- Replace graphics card. See paragraph 12.6.

## 11.13. USB Controllers

### 11.13.1. Required Equipment

PC Doctor CD & USB dongle

### 11.13.2. Test Procedure

In PC Doctor: Run the USB test

### 11.13.3. Fail Procedure

Replace the motherboard. See paragraph 12.16.9.

## 11.14. CMOS

### 11.14.1. Required Equipment

PC Doctor CD & USB dongle

### 11.14.2. Test Procedure

In PC Doctor: Run the CMOS test

### 11.14.3. Fail Procedure

Replace the motherboard. See paragraph 12.16.9.

## 11.15. Motherboard

### 11.15.1. Required Equipment

PC Doctor CD & USB dongle

### 11.15.2. Test Procedure

In PC Doctor: Run the system board test

### 11.15.3. Fail Procedure

Replace the motherboard. See paragraph 12.16.9.

## 11.16. IEEE 1394 Controller

### 11.16.1. Required Equipment

PC Doctor CD & USB dongle

### 11.16.2. Test Procedure

In PC Doctor: Run the IEEE 1394 test

### 11.16.3. Fail Procedure

Replace the motherboard. See paragraph 12.16.9.

## 11.17. Rear Panel Audio Output Connectors

### 11.17.1. Required Equipment

- An external amplifier that has:
  - 2 analogue audio inputs
  - a coaxial SPDIF input
  - an optical SPDIF input
- Cables for each of these four inputs

### 11.17.2. Test Procedure

1. Connect the four audio outputs of the Media Center with the amplifier.
2. In PC Doctor: Run the Sound test.
3. Select the first input on the amplifier and push some on-screen test buttons to get sound on the different boxes.
4. Repeat this for the other three inputs on the amplifier.

### 11.17.3. Fail Procedure

Replace the motherboard. See paragraph 12.16.9.

## 11.18. Wireless Keyboard and Receiver

### 11.18.1. Required Equipment

- PC Doctor CD & USB dongle
- The wireless keyboard that was returned with the set.
- If no keyboard was returned, use your own wireless keyboard.

### 11.18.2. Test Procedure

In PC Doctor: Run the keyboard test and follow the instructions, (if using the keyboard from the customer make sure to push all keys).

### 11.18.3. Fail Procedure

- Re-connect the keyboard with the set. (Press the 'connect' button on the Media Center front panel and then press the connect button on the keyboard).
- Replace the keyboard batteries.
- Replace keyboard.
- Replace the RF board. See paragraph 12.10.
- Replace the motherboard. See paragraph 12.16.9.

## 11.19. Microphone, Headphones and Headphones Volume Control

### 11.19.1. Required Equipment

- PC Doctor CD & USB dongle
- Headset (combined headphones/microphone) with two 9mm jack plugs

### 11.19.2. Test Procedure

1. In PC Doctor: Run the microphone test and follow the instructions.
2. Play the recorded sound a number of times, using the volume buttons to increase and decrease the volume.

### 11.19.3. Fail Procedure

- Replace the FP Audio cable.
- Replace the FP I/O board. See paragraph 12.12.3.
- Replace the motherboard. See paragraph 12.16.9.

## 11.20. Wireless Network Connection (802.11b/g)

### 11.20.1. Required Equipment

Wireless router/access point within range of the Media Center PC

### 11.20.2. Test Procedure

1. In Windows XP, open the Wireless LAN client utility. (Select: Start > All Programs > Wireless LAN).
2. Set-up a connection with the wireless access point: in the Site Survey section select Refresh and Connect with the access point. Make sure that you enter the correct protection key if necessary.

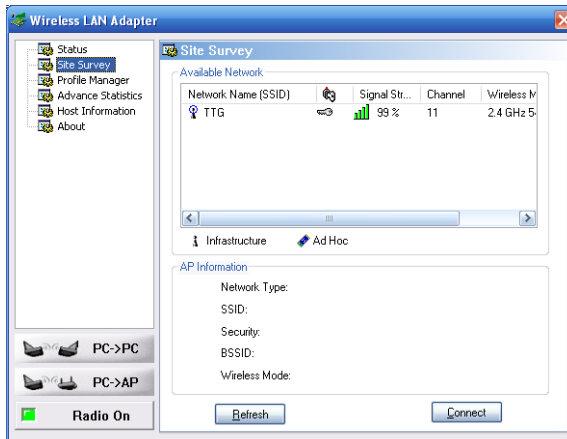

3. Select the Status section. Both link quality and signal strength should now be sufficiently high. (Maximum values are 52.0 Mbps and 100%).

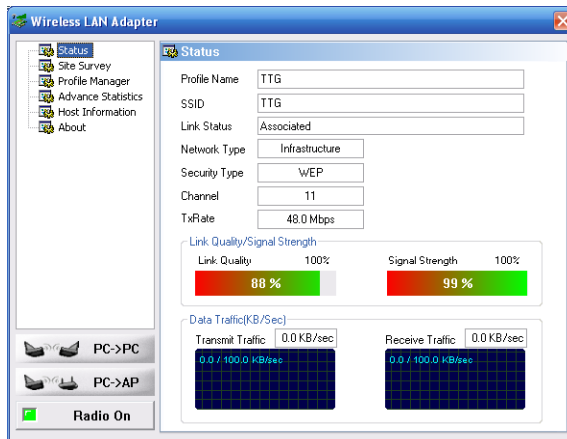

### 11.20.3. Fail Procedure

- Replace both antenna cables and antennas. See paragraphs 12.8.3 and 12.8.5.
- Replace the WLAN card. See paragraph 12.8.1.
- Replace the motherboard. See paragraph 12.16.9.

## 11.21. USB Connectors

### 11.21.1. Required Equipment

USB memory stick or USB mouse

### 11.21.2. Test Procedure

1. Insert the USB device into one of the USB slots.
2. Check that the device is detected and that it functions correctly.
3. Repeat this procedure for each of the four USB slots (2 on the front, 2 at the rear).

### 11.21.3. Fail Procedure

For the front USB connectors:

- Replace the FP\_USB cable.
- Replace the FP I/O board. See paragraph 12.12.3.
- Replace the motherboard. See paragraph 12.16.9.

For the rear USB connectors:

- Replace the motherboard. See paragraph 12.16.9.

## 11.22. IEEE 1394 Connectors

### 11.22.1. Required Equipment

- 1394 device (e.g. external hard disc or a digital camera)
- 4-pin and 6-pin 1394 cables

### 11.22.2. Test Procedure

1. Insert the 1394 device into one of the 1394 slots.
2. Check that the device is detected and that it functions correctly.
3. Repeat this procedure for each of the three 1394 slots (1 on the front, 2 at the rear).

### 11.22.3. Fail Procedure

For the front 1394 connector:

- Replace the 1394 cable.
- Replace the FP I/O board. See paragraph 12.12.3.
- Replace the motherboard. See paragraph 12.16.9.

For the rear 1394 connectors:

- Replace the motherboard. See paragraph 12.16.9.

## 11.23. Graphics Card and Video Output Connectors

### 11.23.1. Required Equipment

- TV and/or Monitor with the following inputs:
  - SCART
  - DVI
  - VGA
  - S-Video
- Cables for each of these inputs

### 11.23.2. Test Procedure

1. Connect the TV and/or monitor to the four video outputs of the Media Center.
2. On the MediaCenter: select the '**Intel® Graphics Media Accelerator Driver**' icon in the icon bar on the bottom right.
3. Select the graphics properties option.
4. Select the '**Intel® Dual Display Clone**' option and make sure that the primary device is '**digital display**' and the secondary device is '**television**'.

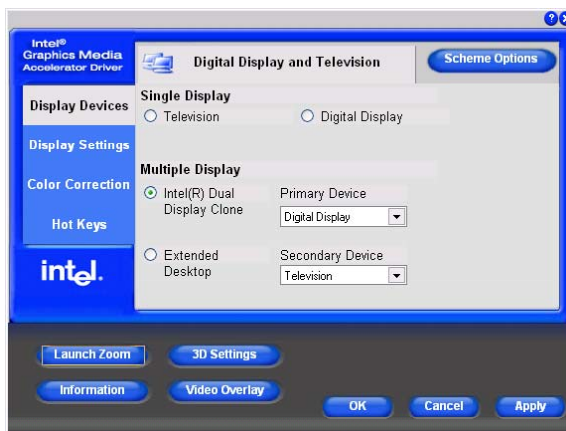

5. Switch you monitor and/or TV between the different inputs to check if the desktop can be seen on all four (Scart, DVI, VGA and S-Video) output modes.
6. Return the set to the original settings.

### 11.23.3. Fail Procedure

For the SCART output:

- Replace the ADD2\_SCART cable.
- Replace SCART connector board. See paragraph 12.16.3.
- Replace PCI-express riser board. See paragraph 12.6.
- Replace graphics card. See paragraph 12.6.
- Replace the motherboard. See paragraph 12.16.9.

For the DVI, VGA or S-Video outputs:

- Replace PCI-express riser board. See paragraph 12.6.
- Replace graphics card. See paragraph 12.6.
- Replace the motherboard. See paragraph 12.16.9.

## 11.24. FM Tuner

### 11.24.1. Required Equipment

RF FM Radio signal source (examples: external FM antenna, cable)

### 11.24.2. Test Procedure

In MediaCenter, select the **Radio** option and search for a channel.



### 11.24.3. Fail Procedure

- Replace the PCI riser card. See paragraph 12.7.1.
- Replace the TV tuner card. See paragraph 12.7.1.
- Replace the motherboard. See paragraph 12.16.9.



## 11.25. TV Tuner Card and Audio/Video Inputs

### 11.25.1. Required Equipment

- RF TV signal source (examples: external TV antenna, cable TV, VCR)
- Composite Video signal source (examples: DVD player, camcorder)
- S-Video signal source (examples: DVD player, camcorder)

### 11.25.2. Test Procedure

1. Connect the Composite Video source to the upper connector on the MCP9350i back panel.
2. Connect the TV signal source to the TV RF-in connector.
3. Go to the TV signal setup section in the Windows Media Center program. (Select: **Settings > TV > Set Up TV Signal**)



4. Acknowledge that the current settings will be deleted (in actuality, the procedure will be cancelled at the end so the settings will remain).



5. Select the correct region.



- Select the manual configuration option (this screen is skipped in some versions).



- Select **Cable or Digital Cable** as the source of the TV signal.



- Select the correct signal type (in general: NTSC for America, PAL/SECAM for Europe).



9. Indicate that you want to install a set top box.



10. The **Which Tuners Do You Want to Configure?** screen will appear. Select **NVIDIA NDTV Dual Tuner Card Tuner 1** (the upper Composite and S-Video connectors).



11. Select **Enter Channel** and enter a channel number that should be available. Check if you can see the expected TV signal in the small video window on the right.



12. Select **Composite Video**. Check for the expected Composite Video signal in the video window.  
 13. Disconnect the Composite Video cables from the MCP9350i. Connect the S-Video source to the upper connector on the back panel.  
 14. Select **S-Video**. Check for the expected S-Video signal in the video window, if necessary click **Scan again** to refresh the display.  
 15. Move the S-Video cable to the lower connector on the MCP9350i back panel.

16. Click on **back** to return to the **Which Tuners Do You Want to Configure?** screen. Select **NVIDIA NDTV Dual Tuner Card Tuner 2**.



17. Repeat the previous S-Video and Composite video checks for Tuner 2.  
18. Click on **'Cancel'** to stop this TV signal installation, without saving the new settings.

### 11.25.3. Fail Procedure

- Replace the PCI riser card. See paragraph 12.7.1.
- Replace the TV tuner card. See paragraph 12.7.1.
- Replace the motherboard. See paragraph 12.16.9.

## 11.26. VFD Display and Buttons

### 11.26.1. Required Equipment

Audio CD

### 11.26.2. Test Procedure

1. Insert an Audio CD into the ODD.
2. Use the transport control buttons located below the VFD display to navigate the CD. Check that each button operates correctly.
3. Check that the VFD display is functioning.

### 11.26.3. Fail Procedure

- Replace the VFD\_USB cable.
- Replace the VFD board. See paragraph 12.13.
- Replace the motherboard. See paragraph 12.16.9.

## 11.27. Remote Control and Infrared Receiver

### 11.27.1. Required Equipment

- Use the remote control that was returned with the Media Center.
- If no remote control was returned, use your own.

### 11.27.2. Test Procedure

Use the volume up and down buttons on the remote control to test correct operation of the infrared receiver and remote.

### 11.27.3. Fail Procedure

- Replace the remote control batteries.
- Replace the remote control.
- Replace the VFD\_USB cable.
- Replace the VFD board. See paragraph 12.13.
- Replace the motherboard. See paragraph 12.16.9.

## 11.28. IR Blaster

### 11.28.1. Required Equipment

- Two IR blaster cables
- Test CD

### 11.28.2. Test Procedure

1. Insert the two IR blaster cables in the rear IR blaster ports.
2. Hold the 'eyes' of the cables in front of the IR receiver in the front of the set (to the left of the VFD display).
3. Open a command window. (Select: **Start > Run**. Type '**cmd**' and click **OK**).
4. In the command window: find and run the program '**IR.bat**'.
5. Check if both cables pass the test. If not, move the 'eyes' a bit and try again until absolutely sure that there is a hardware failure.

### 11.28.3. Fail Procedure

Replace the motherboard. See paragraph 12.16.9.

## 12. Hardware Repair

This section provides instructions on how to remove and replace modules from the Media-Center.

### 12.1. Top Cover

#### 12.1.1. Top Cover Removal

**WARNING:** Disconnect the AC power from the MCP9350i before removing the top cover.

1. At the rear of the chassis remove the 4 torx screws (1). See Figure 12.1-1.
2. Slide the top cover towards the rear, until the locking tabs disengage. See Figure 12.1-2.
3. Lift the top cover straight up and remove it from the chassis.
4. Store the top cover in a safe place.

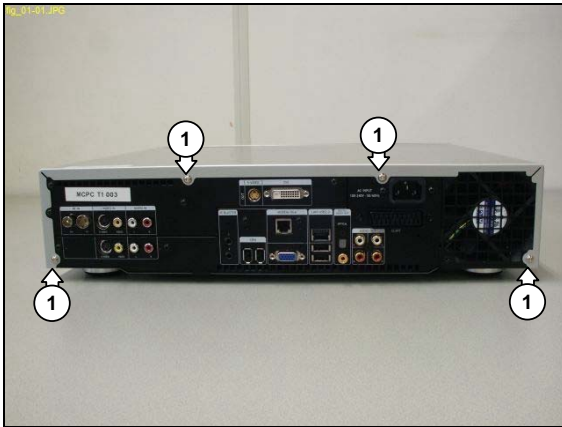

Figure 12.1-1



Figure 12.1-2

#### 12.1.2. Top Cover Re-Assembly

To re-assemble the top cover, do all processes described in paragraph 12.1.1 in reverse order.

**Note:** The torque setting required for the top cover screws (1) is 8kg-cm

**Note:** Check the top cover for damage after re-assembly.

## 12.2. Main Bezel

### 12.2.1. Main Bezel Removal

1. Check the front of the MCP9350i for cosmetic damage. Make a note of any damage.
2. Remove the top cover. See paragraph 12.1.1.
3. At the front of the MCP9350i insert a straightened paper clip into the ODD tray.
4. Push the paper clip until the ODD tray (1) is unlocked. See Figure 12.2-1.
5. Carefully turn the MCP9350i over, so that the bottom side of the chassis is facing up.
6. Carefully pull the ODD tray out to gain access to the underside of the ODD bezel.
7. Release the 2 locking tabs (2), and remove the ODD bezel. See Figure 12.2-2.
8. Store the ODD bezel in a safe place.
9. Push the ODD tray in until it closes.
10. Turn the MCP9350i over, so that the topside of the chassis is facing up.
11. Remove the 2 countersunk screws (3). See Figure 12.2-3.
12. Release the main bezel upper locking tab (4). See Figure 12.2-3.
13. Pull the top of the main bezel forwards and downwards until the bezel is released from the chassis.
14. Remove the main bezel from the chassis.
15. Store the main bezel in a safe place. Avoid touching the inside of the bezel.



Figure 12.2-1

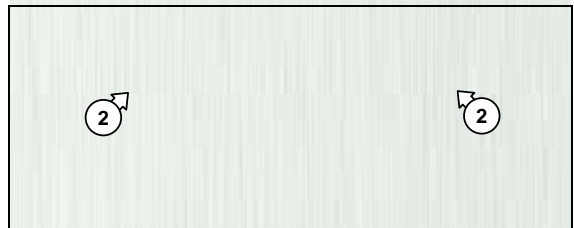

Figure 12.2-2

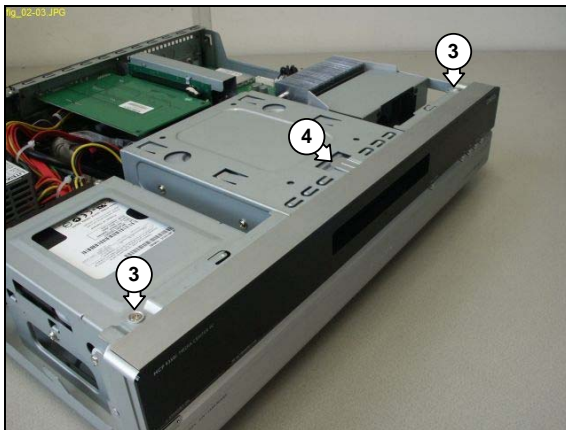

Figure 12.2-3



Figure 12.2-4

### 12.2.2. Main Bezel Re-Assembly

To re-assemble the main bezel, do all processes described in paragraph 12.2.1 in reverse order.

**Note:** Clean the MCP9350i before re-assembly

**Note:** The torque setting required for the main bezel screws (3) is 8kg-cm

**Note:** Check the main bezel and the ODD bezel for cosmetic damage after re-assembly. Replace only when additional damage has been caused during the diagnosis and repair procedure.



## 12.3. HDD (Hard Disk Drive)

### 12.3.1. HDD Subassembly Removal

1. Remove the top cover. See paragraph 12.1.1.
2. Disconnect all cables (1) from the HDD. See Figure 12.3-1.
3. Remove the 2 mounting screws (2) from the HDD subassembly. See Figure 12.3-2.
4. Slide the HDD subassembly towards the left, until the locking tabs disengage.
5. Remove the HDD subassembly from the chassis.



Figure 12.3-1

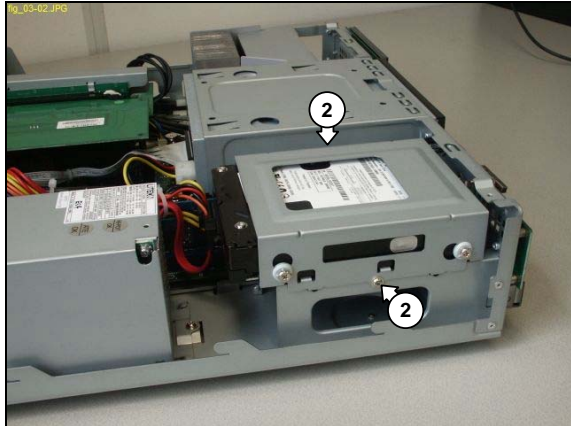

Figure 12.3-2

### 12.3.2. HDD Subassembly Re-Assembly

To re-assemble the HDD subassembly, do all processes described in 12.3.1 paragraph in reverse order.

**Note:** The torque setting required for the HDD subassembly mounting screws (2) is 8kg-cm

### 12.3.3. HDD Removal

1. Remove the HDD subassembly. See paragraph 12.3.1.
2. Remove the 4 mounting screws and bushes from the HDD.
3. Slide the HDD out of the HDD cage.

### 12.3.4. HDD Re-Assembly

To re-assemble the HDD, do all processes described in paragraph 12.3.4 in reverse order.

**Note:** The torque setting required for the HDD mounting screws is 4kg-cm

**Note:** There are no jumpers on the HDD that require configuration.

**Note:** When replacing a HDD a disc image must be installed on the new drive. See paragraph 13.



## 12.4. ODD (Optical Disk Drive)

### 12.4.1. ODD Removal

1. Remove the top cover. See paragraph 12.1.1.
2. Remove the main bezel. See paragraph 12.2.1.
3. Remove the HDD subassembly. See paragraph 12.3.1.
4. Disconnect all cables (1) from the ODD. See Figure 12.4-1.
5. Remove the 2 mounting screws (2) from the ODD. See Figure 12.4-2
6. Remove the ODD from the chassis by sliding it out towards the front.



Figure 12.4-1

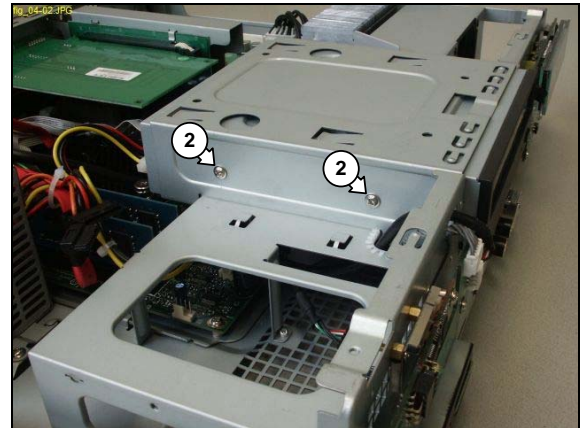

Figure 12.4-2

### 12.4.2. ODD Re-Assembly

To re-assemble the ODD, do all processes described in paragraph 12.4.1 in reverse order.

**Note:** The torque setting required for the ODD mounting screws (2) is 4kg-cm

**Note:** Before re-assembly make sure that the jumper (3) at the rear of the ODD is set to the Master position. See Figure 12.4-3

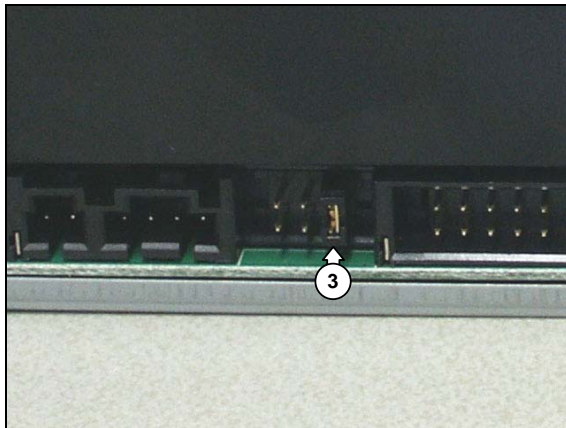

Figure 12.4-3

## 12.5. Riser Card

### 12.5.1. Riser Card Subassembly Removal

1. Remove the top cover. See paragraph 12.1.1.
2. Remove the 2 mounting screws (1) from the riser card subassembly. See Figure 12.5-1.
3. Disconnect the TV daughter card cable (2) from the TV tuner card. See Figure 12.5-2.
4. Push the locking tab arm (3) on the motherboard PCI-E connector to release the PCI-E riser card. See Figure 12.5-2.
5. Pull upwards on the riser card bracket (4) until the riser cards are free from the motherboard connectors. See Figure 12.5-2.
6. Disconnect the SCART cable (5) from the graphic card. See Figure 12.5-3.

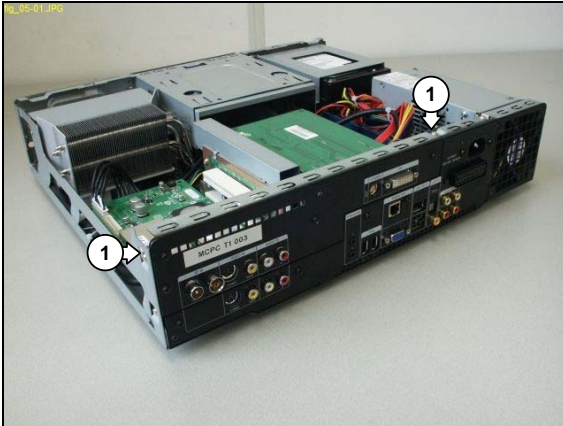

Figure 12.5-1

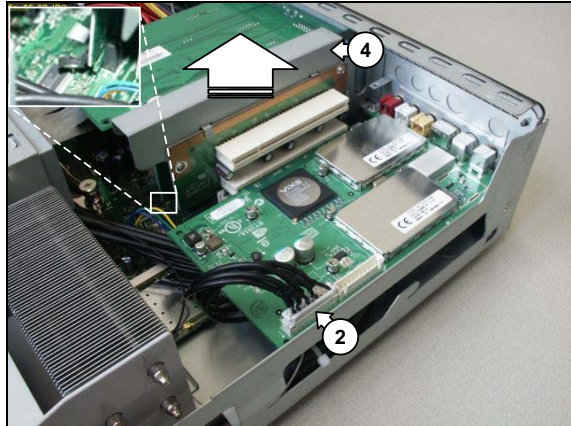

Figure 12.5-2

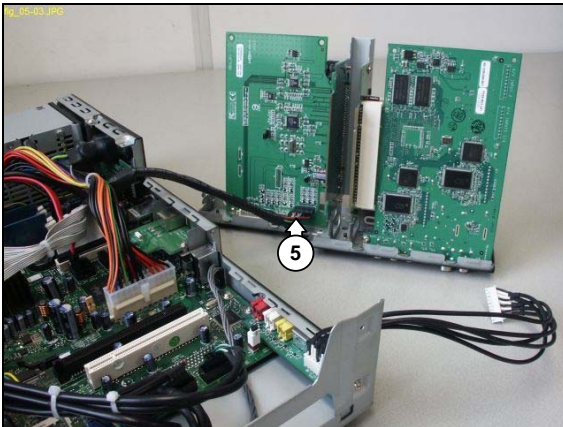

Figure 12.5-3

### 12.5.2. Riser Card Re-Assembly

To re-assemble the riser card subassembly, do all processes described in paragraph 12.5.1 in reverse order.

**Note:** The TV daughter card cable (2) must be connected to A/V Input 2 on the TV tuner card. See Figure 12.5-2.

**Note:** The torque setting required for the riser card subassembly mounting screws (1) is 8kg-cm

## 12.6. Graphic Card

### 12.6.1. Graphic Card Removal

1. Remove the top cover. See paragraph 12.1.1.
2. Remove the riser card subassembly. See paragraph 12.5.1.
3. Remove the 4 mounting screws (1) from the riser card subassembly backplate. See Figure 12.6-1.
4. Remove the 2 screws (2) from the DVI connector. See Figure 12.6-2.
5. Remove the 2 mounting screws (3) from the PCI-E riser card. See Figure 12.6-3.
6. Remove the mounting screw (4) from the graphic card. See Figure 12.6-3.
7. Remove together the graphic card and the PCI-E riser card from the riser bracket.
8. Push the locking tab arm (5) on the PCI-E connector to release the graphic card. See Figure 12.6-4.
9. Pull the graphic card free from the PCI-E riser card connector.

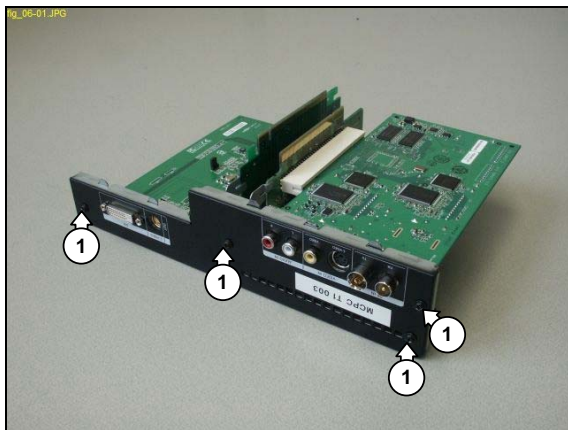

Figure 12.6-1

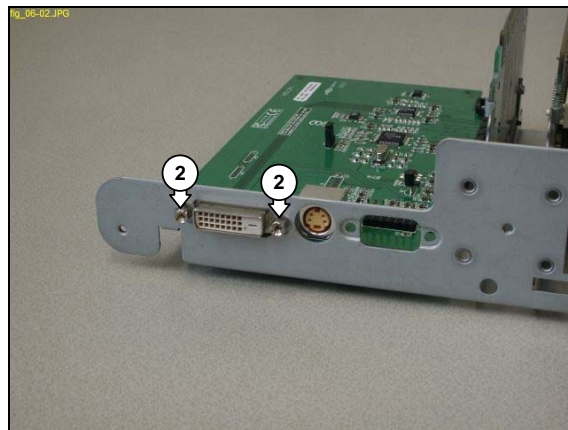

Figure 12.6-2

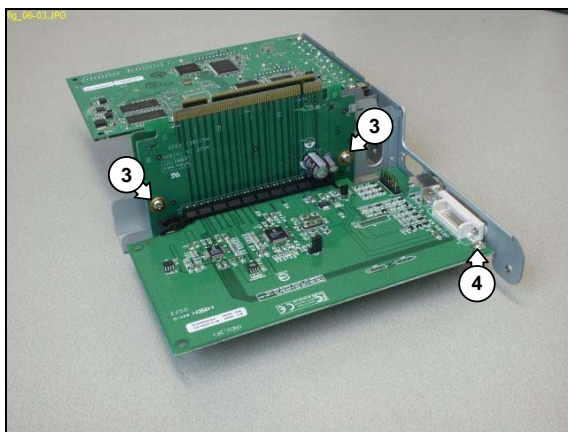

Figure 12.6-3

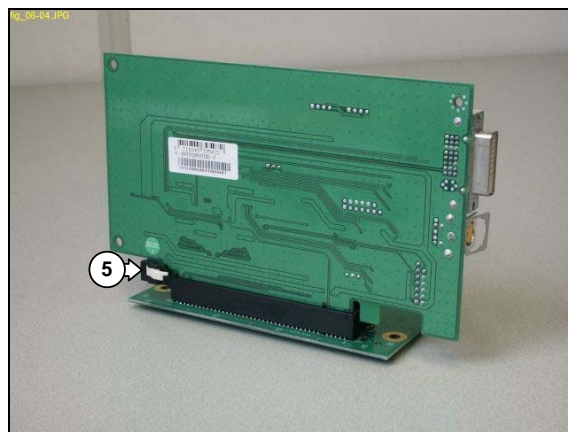

Figure 12.6-4

### 12.6.2. Graphic Card Re-Assembly

To re-assemble the graphic card, do all processes described in paragraph 12.6.1 in reverse order.

- Note:**
- The torque setting required for the graphic card mounting screw (4) is 6kg-cm
  - The torque setting required for the PCI-E riser card mounting screws (3) is 6kg-cm
  - The torque setting required for the DVI connector screws (2) is 6kg-cm
  - The torque setting required for the riser card backplate mounting screws (1) is 8kg-cm



## 12.7. TV Tuner Card & TV Daughterboard

### 12.7.1. TV Tuner Card Removal

1. Remove the top cover. See paragraph 12.1.1.
2. Remove the riser card subassembly. See paragraph 12.5.1.
3. Remove the 4 mounting screws (1) from the riser card subassembly backplate. See Figure 12.7-1.
4. Remove the 2 mounting screws (2) from the PCI riser card. See Figure 12.7-2.
5. Remove the 2 mounting screws (3) from the TV tuner card. See Figure 12.7-3.
6. Remove together the TV tuner card and the PCI riser card from the riser bracket.
7. Pull the TV tuner card free from the PCI riser card connector.

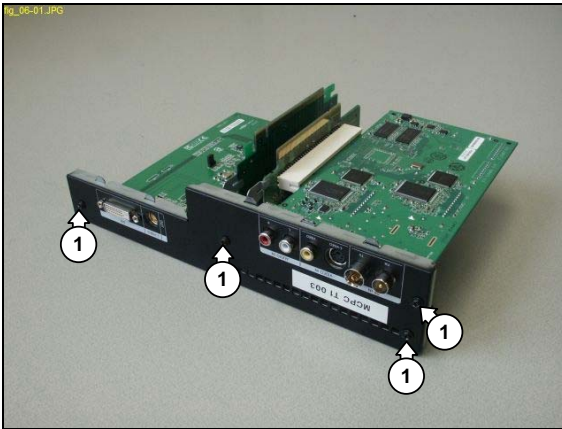

Figure 12.7-1

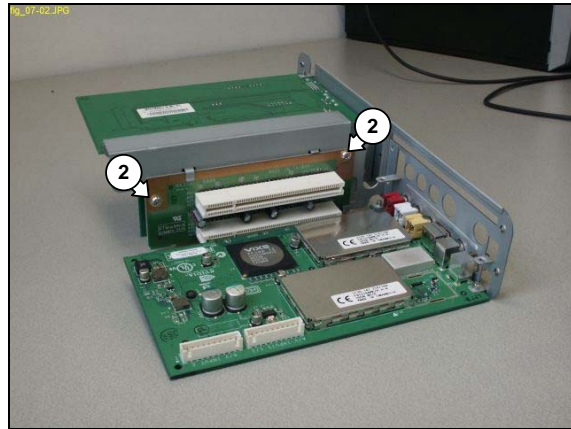

Figure 12.7-2

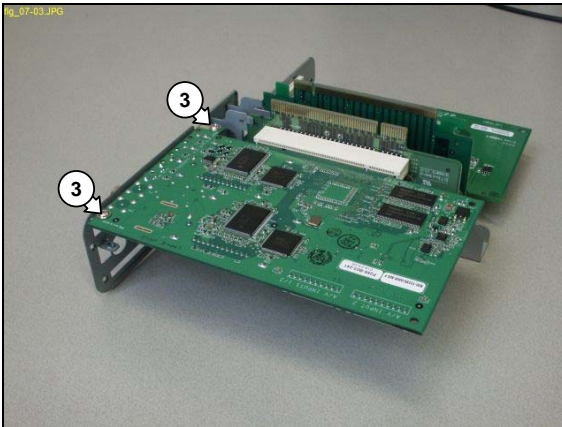

Figure 12.7-3

### 12.7.2. TV Tuner Card Re-Assembly

To re-assemble the TV tuner card, do all processes described in paragraph 12.7.1 in reverse order.

**Note:** Make sure that the TV tuner card is inserted into the correct connector on the PCI riser card.

**Note:** The torque setting required for the TV tuner card mounting screws (3) is 6kg-cm  
 The torque setting required for the PCI riser card mounting screws (2) is 6kg-cm  
 The torque setting required for the riser card backplate mounting screws (1) is 8kg-cm

### 12.7.3. TV Daughterboard Subassembly Removal

1. Remove the top cover. See paragraph 12.1.1.
2. Remove the riser card subassembly. See paragraph 12.5.1.
3. Remove the thermistor (4) from the motherboard. See Figure 12.7-4.
4. Remove the 2 mounting screws (5) from the TV daughterboard subassembly. See Figure 12.7-5.
5. Remove the TV daughterboard subassembly from the chassis.

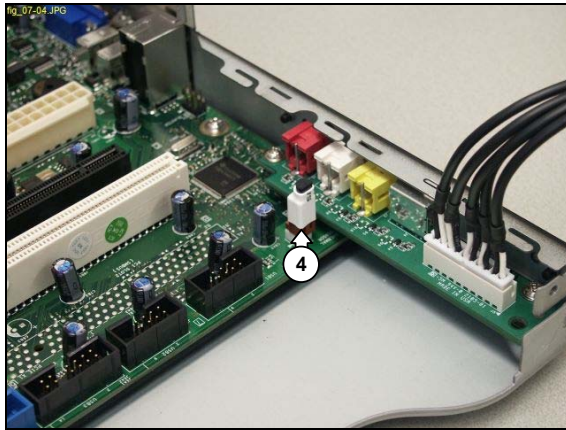

Figure 12.7-4

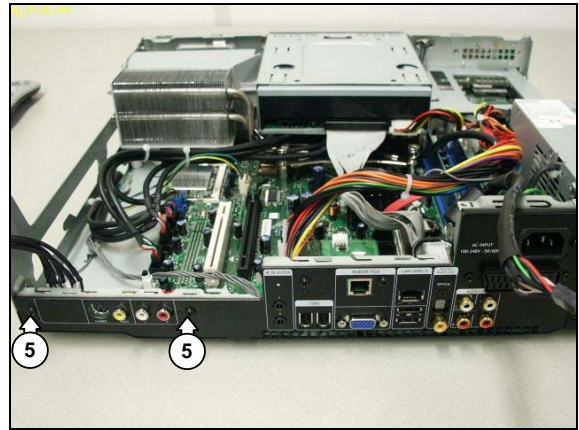

Figure 12.7-5

### 12.7.4. TV Daughterboard Subassembly Re-Assembly

To re-assemble the TV daughterboard subassembly, do all processes described in paragraph 12.7.3 in reverse order.

**Note:** The torque setting required for the TV daughterboard subassembly mounting screws (5) is 8kg-cm

### 12.7.5. TV Daughterboard Removal

1. Remove the top cover. See paragraph 12.1.1.
2. Remove the riser card subassembly. See paragraph 12.5.1.
3. Remove the TV daughterboard subassembly. See paragraph 12.7.3.
4. Disconnect the TV daughterboard cable (6). See Figure 12.7-6.
5. Remove the 2 mounting screws (7) from the TV daughterboard. See Figure 12.7-6.
6. Remove the TV daughterboard from the TV daughterboard cage.

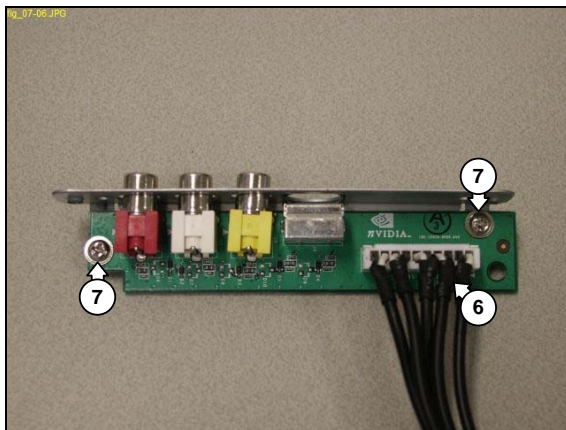

Figure 12.7-6

### 12.7.6. TV Daughterboard Re-Assembly

To re-assemble the TV daughterboard, do all processes described in paragraph 12.7.5 in reverse order.

**Note:** The torque setting required for the TV daughterboard mounting screws (7) is 6kg-cm

## 12.8. WLAN Card & Antenna

### 12.8.1. WLAN Card Removal

1. Remove the top cover. See paragraph 12.1.1.
2. Remove the riser card subassembly. See paragraph 12.5.1.
3. Disconnect the antenna cables (1) from the WLAN card. See Figure 12.8-1.
4. Push the 2 locking tabs (2) outwards to release the WLAN card. See Figure 12.8-1.
5. Remove the WLAN card from the motherboard.

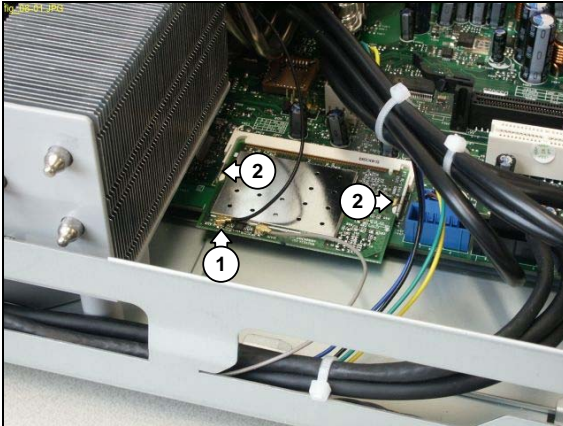

Figure 12.8-1

### 12.8.2. WLAN Card Re-Assembly

To re-assemble the WLAN card, do all processes described in paragraph 12.8.1 in reverse order.

### 12.8.3. Right Wireless Antenna Removal

1. Remove the top cover. See paragraph 12.1.1.
2. Remove the main bezel. See paragraph 12.2.1.
3. Remove the riser card subassembly. See paragraph 12.5.1.
4. Remove the ODD. See paragraph 12.4.1.
5. Remove the CPU heat sink. See paragraph 12.15.1.
6. Remove the 2 mounting screws (3) from the CPU fan. See Figure 12.8-2.
7. Remove the 4 mounting screws (4) from the VFD board. See Figure 12.8-2.
8. Move the CPU fan aside to gain access to the antenna cable.
9. Release the right antenna cable from the cable clips (5). See Figure 12.8-3.
10. Move the VFD board aside to gain access to the antenna mounting screws.
11. Remove the 2 mounting screws (6) from the antenna. See Figure 12.8-4.
12. Disconnect the right antenna cable from the WLAN card.
13. Remove the antenna from the chassis.

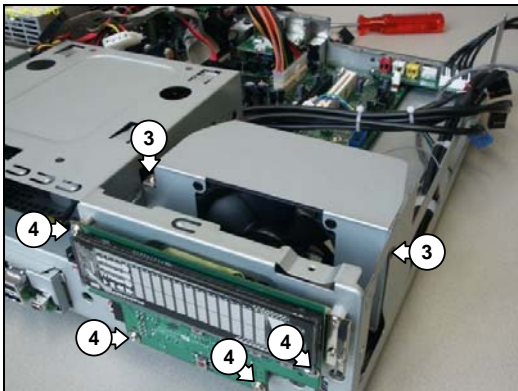

Figure 12.8-2

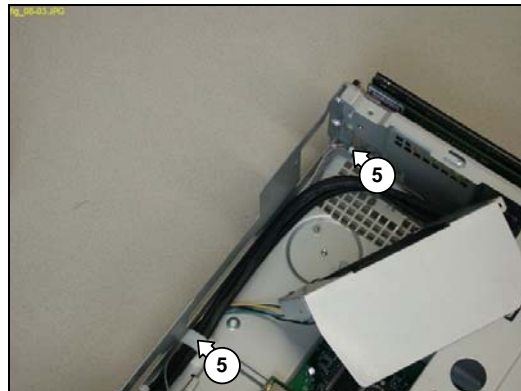

Figure 12.8-3

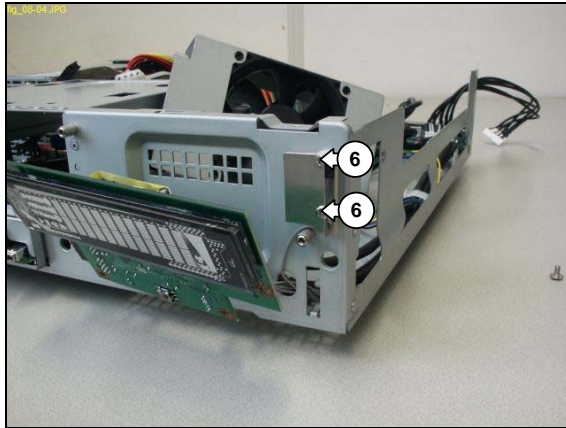

Figure 12.8-4

#### 12.8.4. Right Wireless Antenna Re-Assembly

To re-assemble the right wireless antenna, do all processes described in paragraph 12.8.3 in reverse order.

**Note:** The torque setting required for the antenna mounting screws (6) is 2kg-cm  
The torque setting required for the VFD mounting screws (4) is 6kg-cm  
The torque setting required for the CPU fan mounting screws (3) is 8kg-cm

#### 12.8.5. Left Wireless Antenna Removal

1. Remove the top cover. See paragraph 12.1.1.
2. Remove the main bezel. See paragraph 12.2.1.
3. Remove the HDD subassembly. See paragraph 12.3.1.
4. Remove the ODD. See paragraph 12.4.1.
5. Remove the riser card subassembly. See paragraph 12.5.1.
6. Remove the 2 mounting screws (7) from the antenna. See Figure 12.8-5.
7. Disconnect the left antenna cable from the WLAN card.
8. Remove the antenna from the chassis.

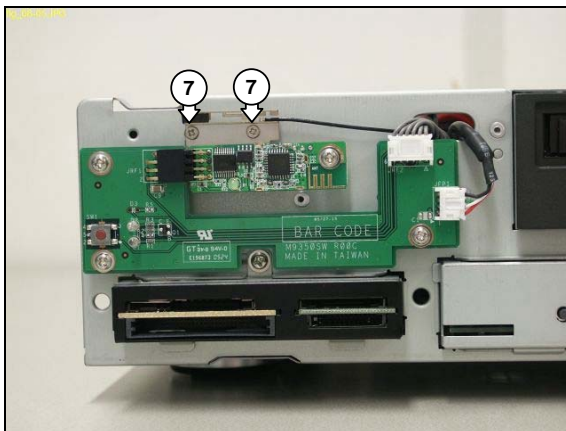

Figure 12.8-5

#### 12.8.6. Left Wireless Antenna Re-Assembly

To re-assemble the left wireless antenna, do all processes described in paragraph 12.8.5 in reverse order.

**Note:** The torque setting required for the antenna mounting screws (7) is 2kg-cm



## 12.9. Modem & RJ11 Connector

### 12.9.1. Modem Card Removal

1. Remove the top cover. See paragraph 12.1.1.
2. Remove the riser card subassembly. See paragraph 12.5.1.
3. Disconnect the PSU cable (1) from the motherboard. See Figure 12.9-1.
4. Disconnect the ATA\_33 cable (2) from the motherboard. See Figure 12.9-1.
5. Disconnect the SATA cable (3) from the motherboard. See Figure 12.9-1.
6. Move the cables aside to gain access to the modem card.
7. Disconnect the MD cable (4) from the RJ11 connector board. See Figure 12.9-2.
8. Remove the mounting screw (5) from the modem card. See Figure 12.9-2.
9. Pull the modem card directly upwards until it is free from the motherboard connector.
10. Remove the modem card.

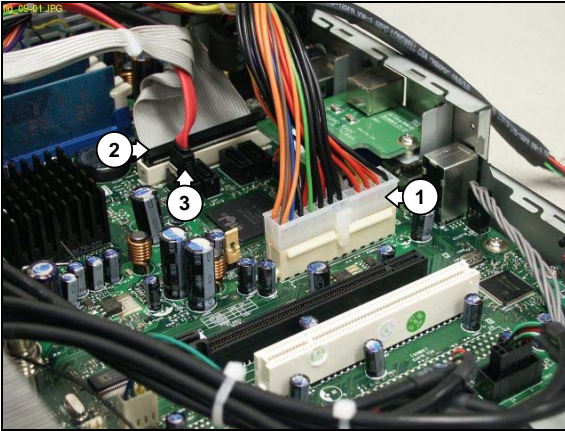

Figure 12.9-1

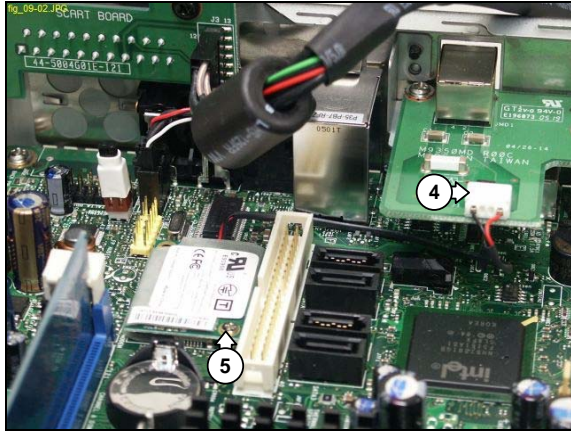

Figure 12.9-2

### 12.9.2. Modem Card Re-Assembly

To re-assemble the modem card, do all processes described in paragraph 12.9.1 in reverse order.

**Note:** The torque setting required for the modem card mounting screw (5) is 6kg-cm

### 12.9.3. RJ11 Connector Subassembly Removal

1. Remove the top cover. See paragraph 12.1.1.
2. Remove the riser card subassembly. See paragraph 12.5.1.
3. Disconnect the PSU cable (1) from the motherboard. See Figure 12.9-1.
4. Disconnect the ATA\_33 cable (2) from the motherboard. See Figure 12.9-1.
5. Disconnect the SATA cable (3) from the motherboard. See Figure 12.9-1.
6. Move the cables aside to gain access to the RJ11 connector subassembly.
7. Disconnect the MD cable (4) from the RJ11 connector board. See Figure 12.9-2.
8. Remove the 2 mounting screws (6) from the RJ11 connector subassembly. See Figure 12.9-3.
9. Remove the RJ11 connector subassembly from the chassis.

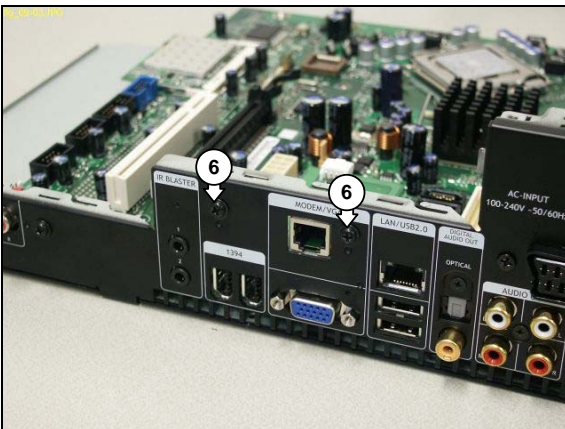

Figure 12.9-3



#### 12.9.4. RJ11 Connector Subassembly Re-Assembly

To re-assemble the RJ11 connector subassembly, do all processes described in paragraph 12.9.3 in reverse order.

**Note:** The torque setting required for the RJ11 connector subassembly mounting screws (6) is 8kg-cm

#### 12.9.5. RJ11 Board Replacement

1. Remove the RJ11 connector subassembly. See paragraph 12.9.3.
2. Remove the 2 mounting screws (7) from the RJ11 board. See Figure 12.9-4.
3. Remove the RJ11 board from the RJ11 cage.

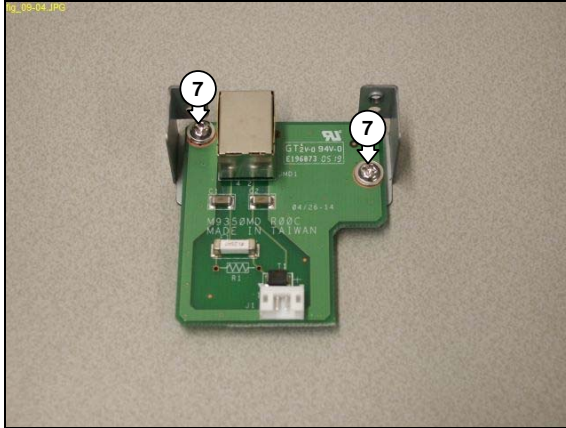

Figure 12.9-4

#### 12.9.6. RJ11 Board Re-Assembly

To re-assemble the RJ11 board, do all processes described in paragraph 12.9.5 in reverse order.

**Note:** The torque setting required for the RJ11 board mounting screws (7) is 6kg-cm.

## 12.10. SW Board & RF Receiver

### 12.10.1. SW Board & RF Receiver Removal

1. Remove the top cover. See paragraph 12.1.1.
2. Remove the main bezel. See paragraph 12.2.1.
3. Disconnect all cables (1) from the SW board & RF receiver. See Figure 12.10-1.
4. Remove the 4 mounting screws (2) from the SW board & RF receiver. See Figure 12.10-1.
5. Remove the SW board & RF receiver from the chassis.

**Note:** The RF receiver may be removed from the SW board by carefully pulling it out of its connector.

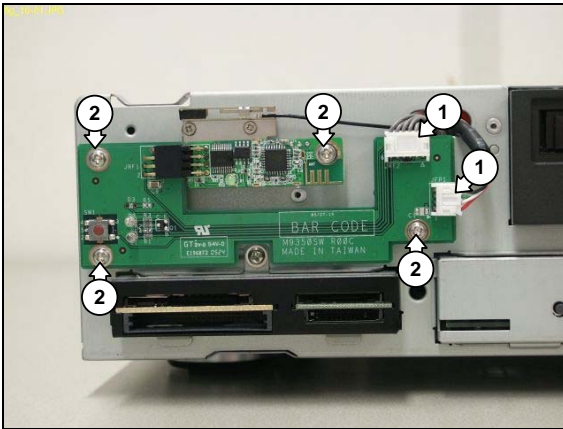

Figure 12.10-1

### 12.10.2. SW Board & RF Receiver Board Re-Assembly

To re-assemble the SW board & RF receiver, do all processes described in paragraph 12.10.1 in reverse order.

**Note:** The torque setting required for the SW board & RF receiver mounting screws (2) is 6kg-cm

## 12.11. Card Reader

### 12.11.1. Card Reader Subassembly Removal

1. Remove the top cover. See paragraph 12.1.1.
2. Remove the main bezel. See paragraph 12.2.1.
3. Remove the HDD subassembly. See paragraph 12.3.1.
4. Disconnect the cable (1) from the rear of the card reader board. See Figure 12.11-1.
5. Remove the mounting screw (2) from the card reader subassembly. See Figure 12.11-2.
6. Slide the card reader subassembly out from the chassis and remove it.

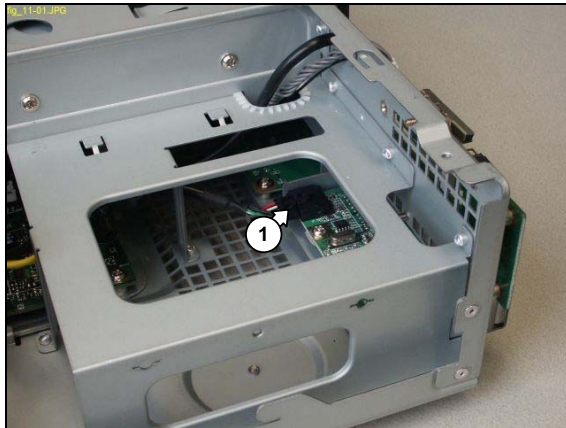

Figure 12.11-1

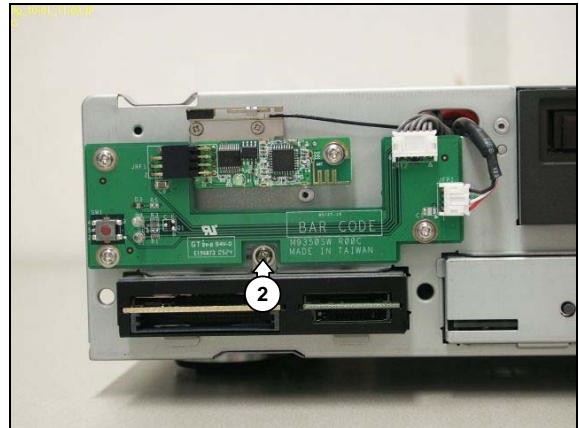

Figure 12.11-2

### 12.11.2. Card Reader Subassembly Re-Assembly

To re-assemble the card reader subassembly, do all processes described in paragraph 12.11.1 in reverse order.

**Note:** The torque setting required for the card reader subassembly mounting screw (2) is 6kg-cm

### 12.11.3. Card Reader Board Removal

1. Remove the card reader subassembly. See paragraph 12.11.1.
2. Remove the 3 mounting screws (3) from the card reader board. See Figure 12.11-3.
3. Remove the card reader board from the card reader cage.

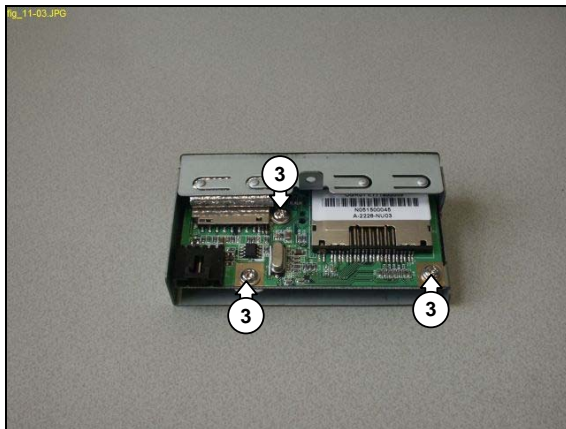

Figure 12.11-3

### 12.11.4. Card Reader Board Re-Assembly

To re-assemble the card reader board, do all processes described in paragraph 12.11.3 in reverse order.

**Note:** The torque setting required for the card reader board mounting screws (3) is 6kg-cm

## 12.12. FP I/O Board

### 12.12.1. FP I/O Board Subassembly Removal

1. Remove the top cover. See paragraph 12.1.1.
2. Remove the main bezel. See paragraph 12.2.1.
3. Remove the HDD subassembly. See paragraph 12.3.1.
4. Remove the ODD. See paragraph 12.4.1.
5. Remove the riser card subassembly. See paragraph 12.5.1.
6. Remove the 2 cable ties (1) to allow some slack in the cables connected to the FP board. See Figure 12.12-1.
7. Remove the mounting screw (2) from the FP I/O board subassembly. See Figure 12.12-2.
8. Slide the FP I/O board subassembly out from the chassis.
9. Disconnect all cables (3) from the rear of the FP I/O board. See Figure 12.12-3.
10. Remove the FP I/O board.

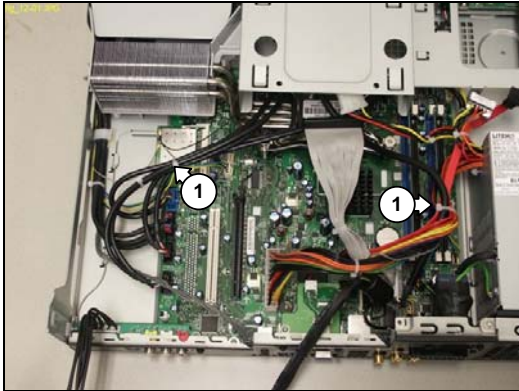

Figure 12.12-1

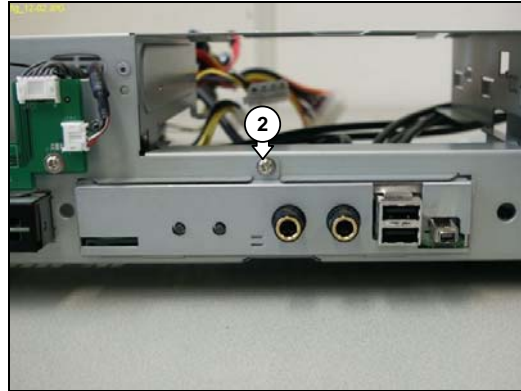

Figure 12.12-2

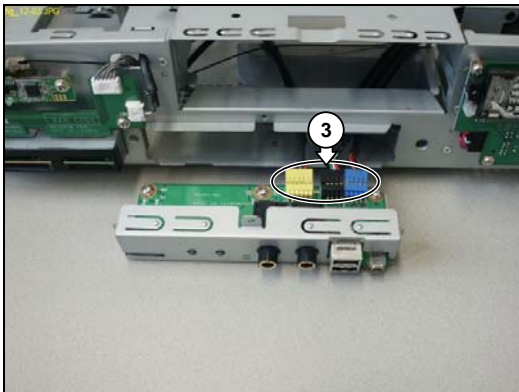

Figure 12.12-3

### 12.12.2. FP I/O Board Subassembly Re-Assembly

To re-assemble the FP I/O board subassembly, do all processes described in paragraph 12.12.1 in reverse order.

**Note:** The torque setting required for the FP I/O board subassembly mounting screw (2) is 8kg-cm

**Note:** Fit replacement cable ties after re-assembly.

### 12.12.3. FP I/O Board Replacement

1. Remove the FP I/O board subassembly. See paragraph 12.12.1.
2. Remove the 3 mounting screws (4) from the FP I/O board. See Figure 12.12-4.
3. Remove the FP I/O board from the FP I/O board cage.

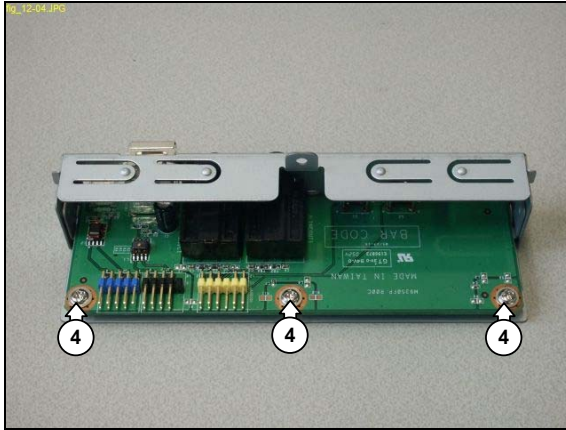

Figure 12.12-4

### 12.12.4. FP I/O Board Re-Assembly

To re-assemble the FP I/O board, do all processes described in paragraph 12.12.3 in reverse order.

**Note:** The torque setting required for the FP I/O board mounting screws (4) is 6kg-cm

## 12.13. VFD Board

### 12.13.1. VFD Board Removal

1. Remove the top cover. See paragraph 12.1.1.
2. Remove the main bezel. See paragraph 12.2.1.
3. Remove the 2 mounting screws (1) from the CPU fan subassembly. See Figure 12.13-1.
4. Move the CPU fan aside to allow some slack in the cables connected to the VFD board. See Figure 12.13-2.
5. Remove the 4 mounting screws (2) from the VFD board. See Figure 12.13-3.
6. Carefully pull the VFD Board away from the chassis to gain access to the cable connectors.
7. Disconnect all cables from the VFD board.
8. Remove the VFD board.

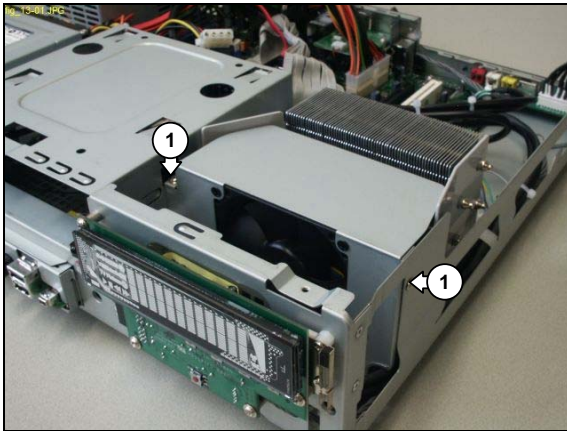

Figure 12.13-1



Figure 12.13-2

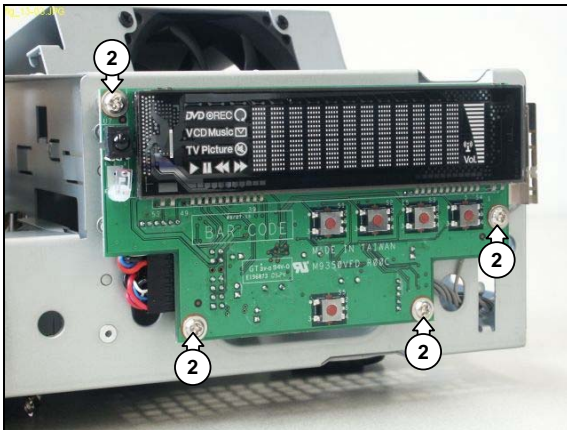

Figure 12.13-3

### 12.13.2. VFD Board Re-Assembly

To re-assemble the VFD board, do all processes described in paragraph 12.13.1 in reverse order.

**Note:** The torque setting required for the VFD board mounting screws (2) is 6kg-cm  
The torque setting required for the CPU fan subassembly mounting screws (1) is 8kg-cm

**Note:** Make sure all cables are correctly routed during re-assembly.



## 12.14. PSU

### 12.14.1. PSU Removal

1. Remove the top cover. See paragraph 12.1.1.
2. Remove the main bezel. See paragraph 12.2.1.
3. Remove the HDD subassembly. See paragraph 12.3.1.
4. Remove the ODD. See paragraph 12.4.1.
5. Remove the riser card subassembly. See paragraph 12.5.1.
6. Remove the CPU heat sink. See paragraph 12.15.1.
7. Remove the motherboard subassembly. See paragraph 12.16.1.
8. Remove cable ties (1) from the PSU cables. See Figure 12.14-1.
9. Remove the mounting screw (2) from the PSU. See Figure 12.14-2.
10. Slide the PSU towards the front of the chassis to release it from the locking tabs.
11. Remove the PSU from the chassis.

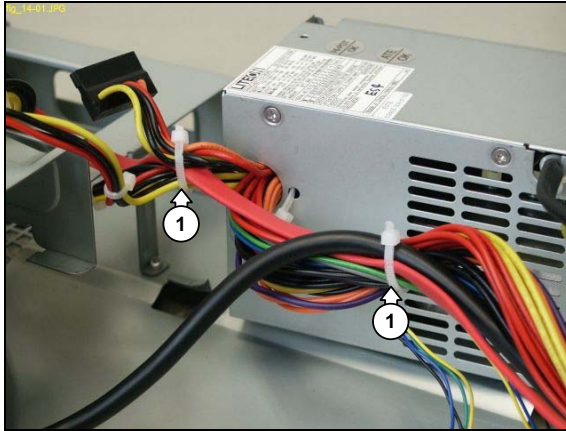

Figure 12.14-1

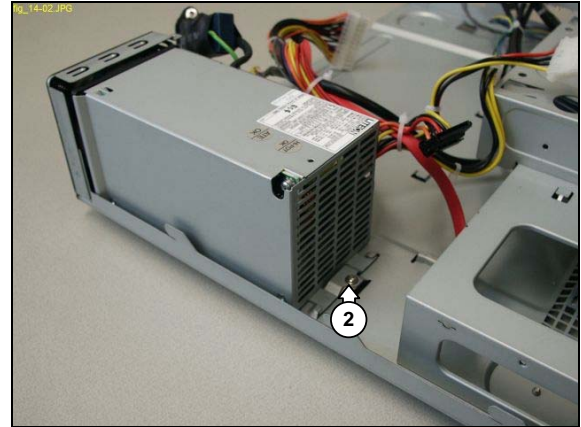

Figure 12.14-2

### 12.14.2. PSU Re-Assembly

To re-assemble the PSU, do all processes described in paragraph 12.14.1 in reverse order.

**Note:** The torque setting required for the PSU mounting screw (2) is 8kg-cm

**Note:** Fit replacement cable ties after re-assembly.

### 12.14.3. PSU Fan Removal

1. Remove the top cover. See paragraph 12.1.1.
2. Remove the HDD subassembly. See paragraph 12.3.1.
3. Remove the riser card subassembly. See paragraph 12.5.1.
4. Remove cable ties (1) from the PSU cables. See Figure 12.14-1.
5. Remove the mounting screw (2) from the PSU. See Figure 12.14-2.
6. Disconnect the PSU fan cable (3) from the motherboard. See Figure 12.14-3.
7. Remove the 2 mounting screws (4) from the AC input. See Figure 12.14-4.
8. Slide the PSU towards the front of the chassis to gain access to the PSU fan. See Figure 12.14-5.
9. Remove the 3 mounting screws (5) from the PSU fan. See Figure 12.14-6.
10. Remove the PSU fan from the chassis.

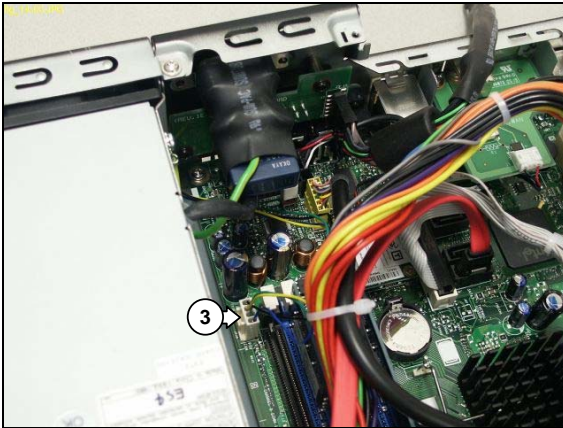

Figure 12.14-3

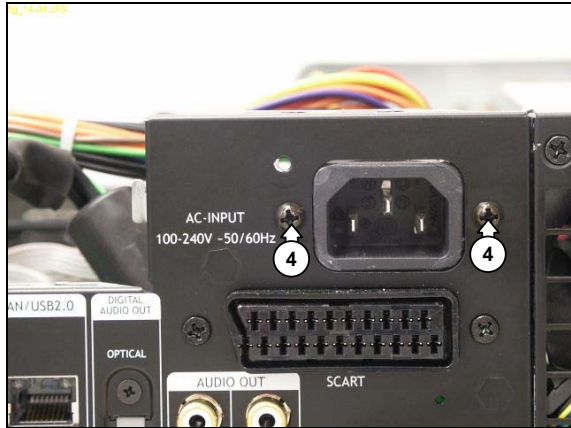

Figure 12.14-4

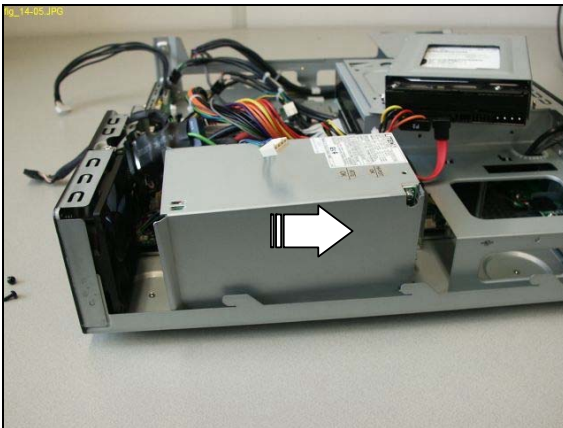

Figure 12.14-5

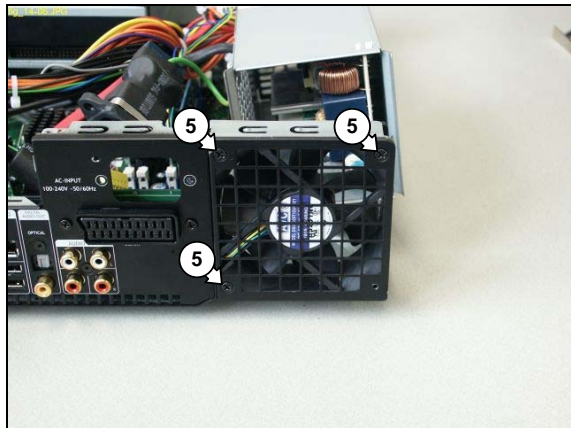

Figure 12.14-6

### 12.14.4. PSU Fan Re-Assembly

To re-assemble the PSU fan, do all processes described in paragraph 12.14.3 in reverse order.

**Note:** The torque setting required for the PSU fan mounting screws (5) is 8kg-cm  
 The torque setting required for the AC input mounting screws (4) is 6kg-cm  
 The torque setting required for the PSU mounting screw (2) is 8kg-cm

**Note:** Make sure that the 3 PSU fan mounting screws (5) are placed in the correct holes. Refer to Figure 12.14-6.

**Note:** Fit replacement cable ties after re-assembly.



## 12.15. CPU Heat Sink

### 12.15.1. CPU Heat Sink Removal

1. Remove the top cover. See paragraph 12.1.1.
2. Remove the main bezel. See paragraph 12.2.1.
3. Remove the HDD subassembly. See paragraph 12.3.1.
4. Remove the ODD. See paragraph 12.4.1.
5. Remove the riser card subassembly. See paragraph 12.5.1.
6. Disconnect the 3 USB cables (1) from the motherboard. See Figure 12.15-1.
7. Disconnect the 1394 cable (2) from the motherboard. See Figure 12.15-1.
8. Disconnect the CPU fan cable (3) from the motherboard. See Figure 12.15-1.
9. Disconnect the left WLAN antenna cable (4) from the WLAN card. See Figure 12.15-2.
10. Move the cables aside to allow access to the CPU heat sink.
11. Undo the 4 mounting screws (5) of the CPU heat sink. See Figure 12.15-3.
12. Remove the CPU heat sink and duct from the motherboard, taking care not to catch any cables.

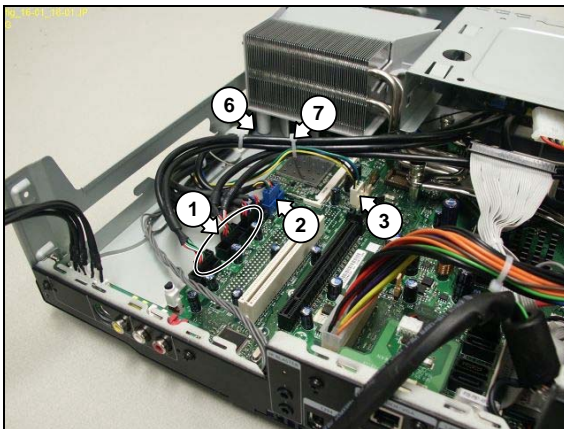

Figure 12.15-1

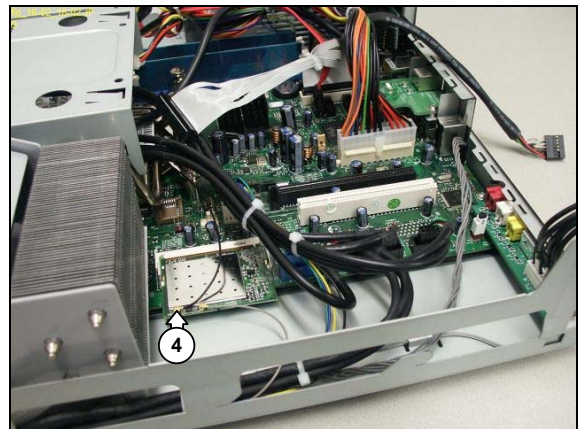

Figure 12.15-2

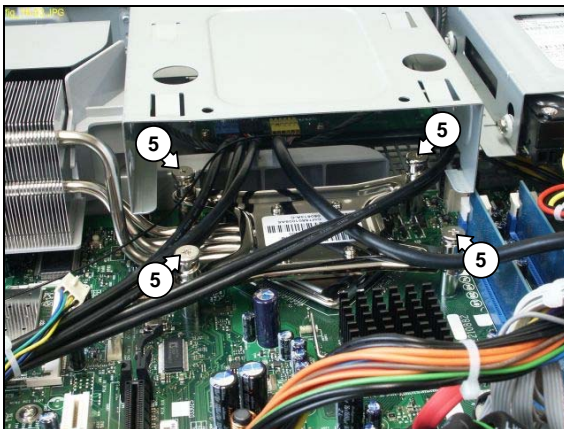

Figure 12.15-3

### 12.15.2. CPU Heat Sink Re-Assembly

To re-assemble the CPU heat sink, do all processes described in paragraph 12.15.1 in reverse order.

**Note:** Remove and re-apply fresh thermal compound between the CPU and the heat sink.

**Note:** Make sure that the CPU heat sink duct is correctly seated on the chassis locating point (6). See Figure 12.15-1.

**Note:** The torque setting required for the CPU heat sink mounting screws (5) is 6kg-cm

### 12.15.3. CPU Fan Subassembly Removal

1. Remove the CPU heat sink. See paragraph 12.15.1.
2. Remove the cable tie (7) from the CPU fan cable. See Figure 12.15-1.
3. Remove the 2 mounting screws (8) from the CPU fan subassembly. See Figure 12.15-4.
4. Remove the CPU fan cable from the cable clip (9). See Figure 12.15-5.
5. Remove the CPU fan subassembly from the chassis.

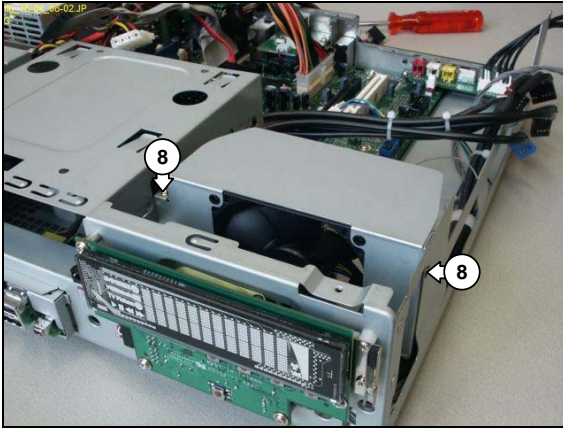

Figure 12.15-4

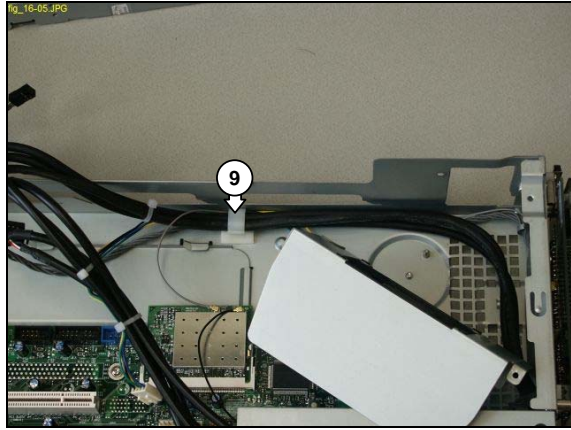

Figure 12.15-5

### 12.15.4. CPU Fan Subassembly Re-Assembly

To re-assemble the CPU fan subassembly, do all processes described in paragraph 12.15.3 in reverse order.

**Note:** The torque setting required for the CPU fan subassembly mounting screws (8) is 8kg-cm

**Note:** Cables must be re-assembled into the cable clip in the following order: right WLAN antenna cable, CPU fan cable, IR blaster cable, and VFD USB cable.

**Note:** Fit replacement cable ties after re-assembly.

### 12.15.5. CPU Fan Removal

1. Remove the CPU fan subassembly. See paragraph 12.15.1.
2. Remove the 4 mounting screws (10) from the CPU fan. See Figure 12.15-6.
3. Remove the fan from the CPU fan cage.

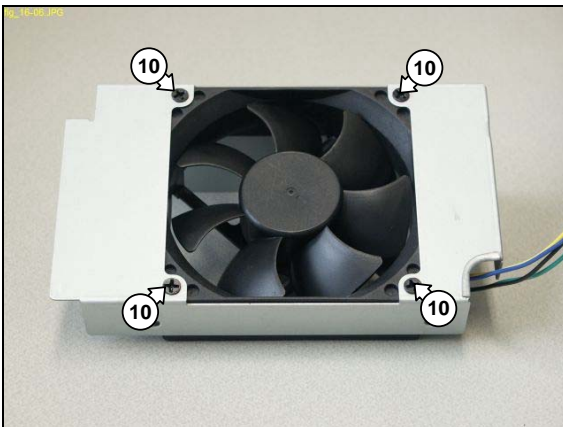

Figure 12.15-6

### 12.15.6. CPU Fan Re-Assembly

To re-assemble the CPU fan, do all processes described in paragraph 12.15.5 in reverse order.

**Note:** The torque setting required for the CPU fan mounting screws (10) is 8kg-cm



## 12.16. Motherboard

### 12.16.1. Motherboard Subassembly Removal

1. Remove the top cover. See paragraph 12.1.1.
2. Remove the main bezel. See paragraph 12.2.1.
3. Remove the HDD subassembly. See paragraph 12.3.1.
4. Remove the ODD. See paragraph 12.4.1.
5. Remove the riser card subassembly. See paragraph 12.5.1.
6. Remove the CPU heat sink. See paragraph 12.15.1.
7. Disconnect the 3 USB cables (1) from the motherboard. See Figure 12.16-1.
8. Disconnect the 1394 cable (2) from the motherboard. See Figure 12.16-1.
9. Disconnect the CPU fan cable (3) from the motherboard. See Figure 12.16-1.
10. Disconnect the WLAN antenna cables (4) from the WLAN card. See Figure 12.16-2.
11. Disconnect the IR blaster cable (5) from the motherboard. See Figure 12.16-2.
12. Disconnect the PSU main power cable (6) from the motherboard. See Figure 12.16-2.
13. Disconnect the FP audio cable (7) from the motherboard. See Figure 12.16-3.
14. Disconnect the PSU fan cable (8) from the motherboard. See Figure 12.16-3.
15. Disconnect the ATA33 cable (9) from the motherboard. See Figure 12.16-3.
16. Disconnect the SATA cable (10) from the motherboard. See Figure 12.16-3.
17. Remove the 2 mounting screws (11) from the AC input. See Figure 12.16-4.
18. Move the cables aside to allow clear access to the motherboard subassembly. See Figure 12.16-5.
19. Remove the 2 mounting screws (12) from the motherboard subassembly. See Figure 12.16-5.
20. Slide the motherboard subassembly towards the rear of the chassis. See Figure 12.16-6.
21. Disconnect the PSU +12v cable (13) from the motherboard. See Figure 12.16-6.
22. Remove the motherboard subassembly from the chassis.

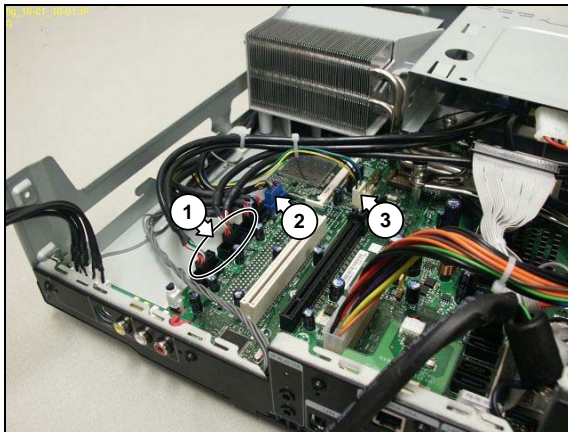

Figure 12.16-1

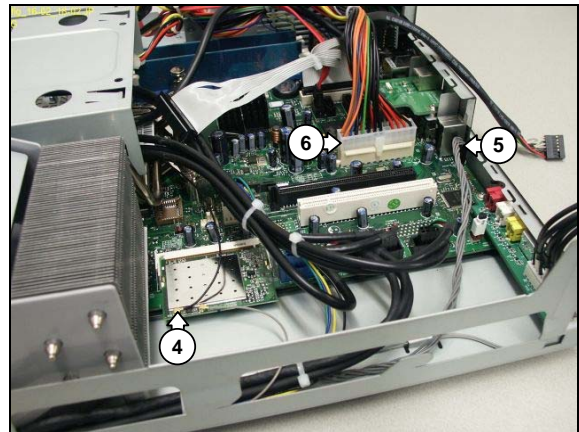

Figure 12.16-2

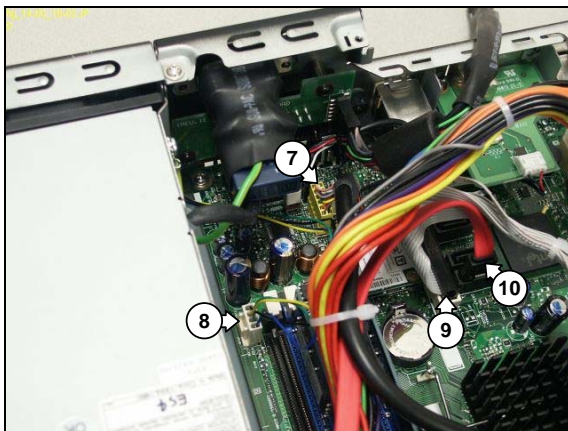

Figure 12.16-3

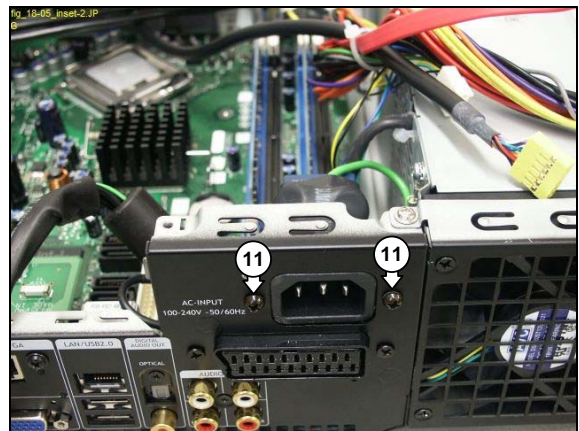

Figure 12.16-4

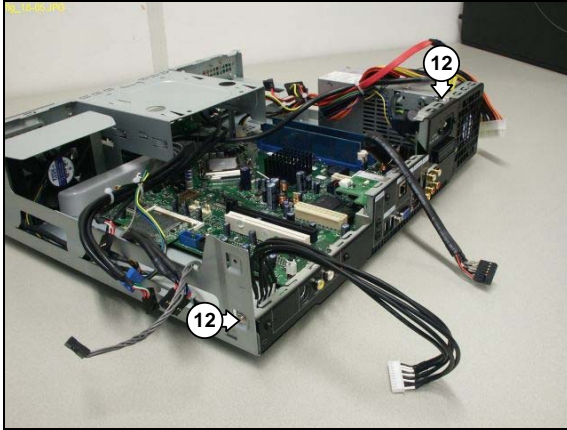

Figure 12.16-5

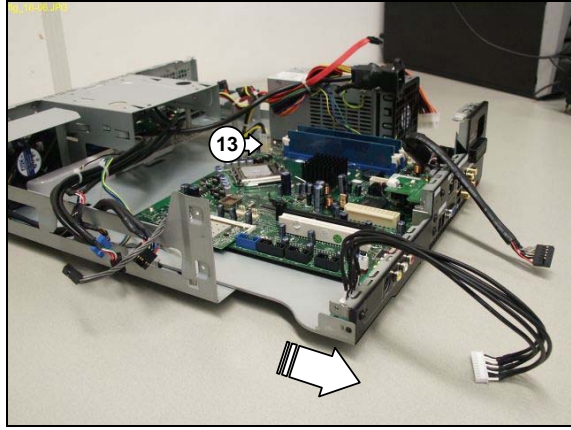

Figure 12.16-6

### 12.16.2. Motherboard Subassembly Re-Assembly

To re-assemble the motherboard subassembly, do all processes described in paragraph 12.16.1 in reverse order.

**Note:** The torque setting required for the motherboard subassembly mounting screws (12) is 8kg-cm  
The torque setting required for the AC input mounting screws (11) is 6kg-cm

**Note:** Remove and re-apply fresh thermal transfer compound between the CPU and the heat sink.

### 12.16.3. SCART Daughterboard Removal

1. Remove the motherboard subassembly. See paragraph 12.16.1.
2. Disconnect the ADD2 SCART cable (14) from the motherboard. See Figure 12.16-7.
3. Disconnect the ADD2 SCART cable (15) from the SCART daughterboard. See Figure 12.16-7.
4. Remove the 2 mounting screws (16) from the SCART daughterboard. See Figure 12.16-7.
5. Remove the 2 mounting screws (17) from the SCART connector. See Figure 12.16-8.
6. Remove the SCART daughterboard from the chassis.

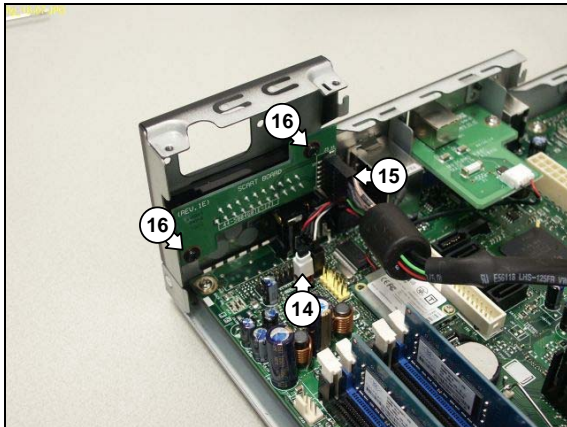

Figure 12.16-7

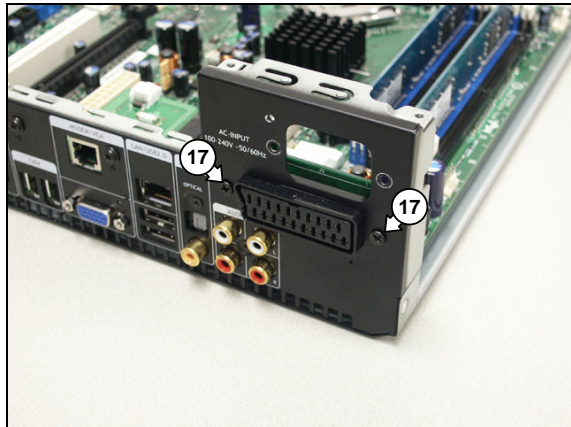

Figure 12.16-8

### 12.16.4. SCART Daughterboard Re-Assembly

To re-assemble the SCART daughterboard, do all processes described in paragraph 12.16.3 in reverse order.

**Note:** The torque setting required for the SCART connector mounting screws (17) is 4kg-cm  
The torque setting required for the SCART daughterboard mounting screws (16) is 6kg-cm



### 12.16.5. CPU Replacement

1. Remove the motherboard subassembly. See paragraph 12.16.1.
2. Release the CPU mounting clamp (18). See Figure 12.16-9.
3. Remove the CPU from the socket.

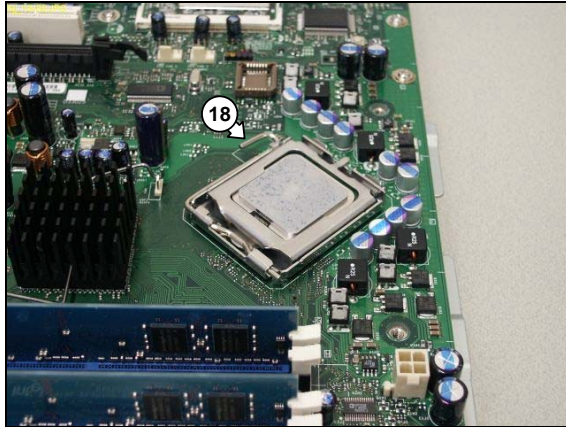

Figure 12.16-9

### 12.16.6. CPU Re-Assembly

To re-assemble the CPU, do all processes described in paragraph 12.16.5 in reverse order.

**Note:** Apply thermal transfer compound between the CPU and the heat sink.

### 12.16.7. DIMM Replacement

1. Remove the motherboard subassembly. See paragraph 12.16.1.
2. Release the retaining clips (19) on the DIMM connector. See Figure 12.16-10.
3. Remove the DIMM from the motherboard.

**Note:** When a specific DIMM has been identified as faulty by a software test make sure that you can match the identification to the relevant DIMM connector on the motherboard. See Figure 12.16-11 for information on DIMM connector identification.

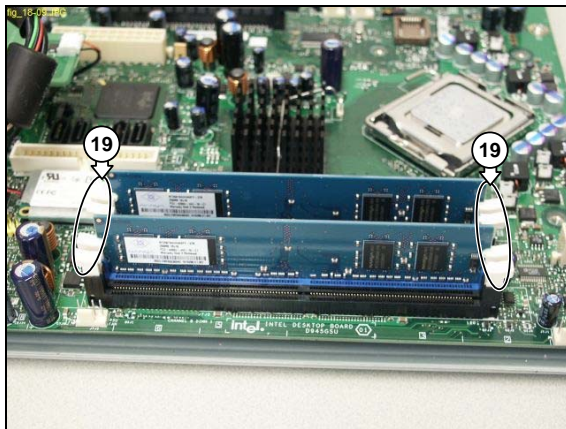

Figure 12.16-10

### 12.16.8. DIMM Re-Assembly

To re-assemble the DIMM, do all processes described in paragraph 12.16.7 in reverse order.

**Note:** The DIMM connectors must be populated in the correct sequence. See figure 12.16-11 for connector identification and population sequence.

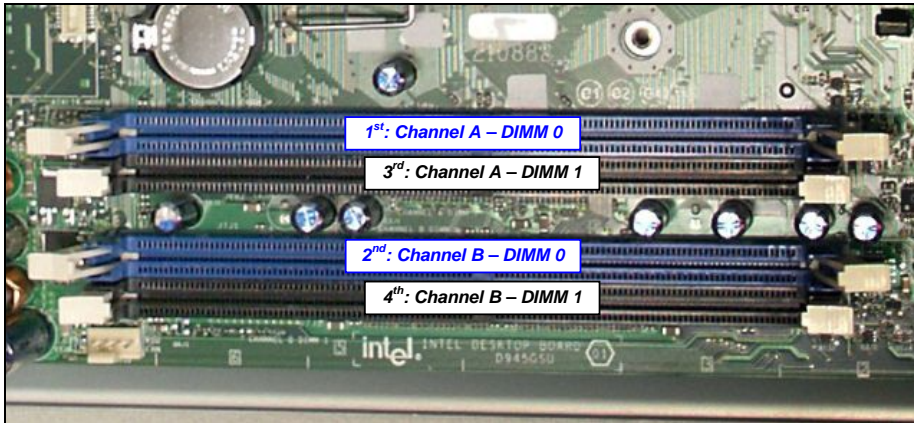

Figure 12.16-11

### 12.16.9. Motherboard Replacement

1. Remove the motherboard subassembly. See paragraph 12.16.1.
2. Remove the 2 thermistors (20). See Figure 12.16-12.
3. Remove the SCART daughterboard. See paragraph 12.16.3.
4. Remove the CPU. See paragraph 12.16.5.
5. Remove all DIMMs. See paragraph 12.16.7.
6. Remove the TV tuner daughterboard subassembly. See paragraph 12.7.3.
7. Remove the WLAN card. See paragraph 12.8.1.
8. Remove the modem board. See paragraph 12.9.1.
9. Remove the RJ11 connector subassembly. See paragraph 12.9.3.
10. Remove the 2 mounting screws (21) from the motherboard tray back plate. See Figure 12.16-13.
11. Remove the 7 mounting screws (22) from the motherboard tray base. See Figure 12.16-14.
12. Remove the motherboard from the motherboard tray.

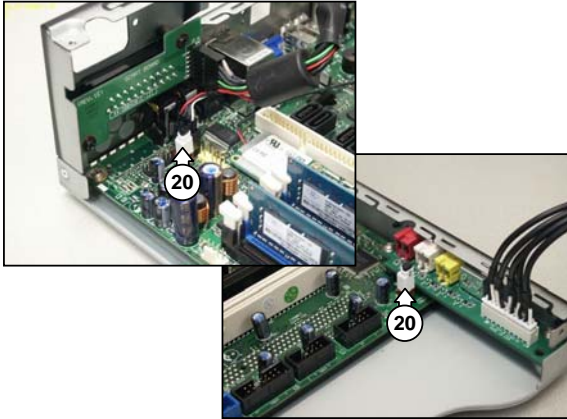

Figure 12.16-12

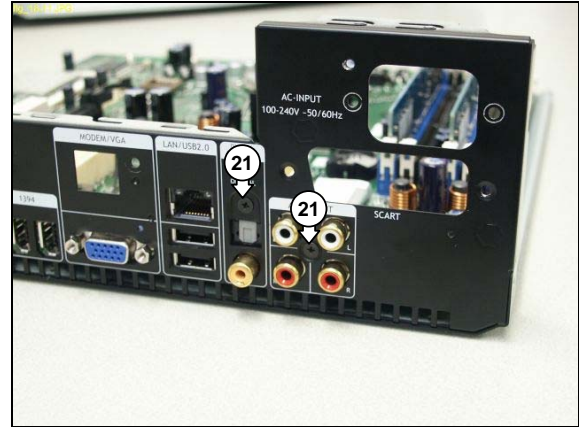

Figure 12.16-13

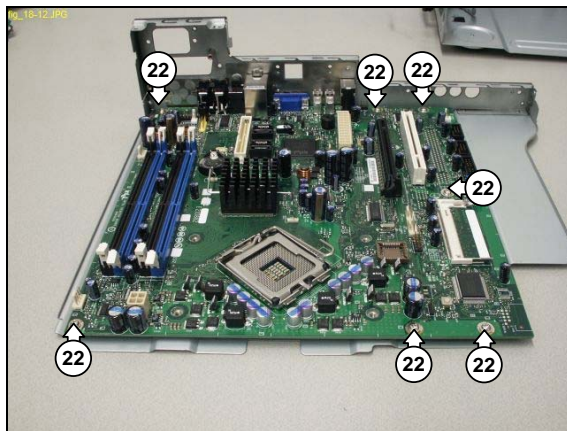

Figure 12.16-14

### 12.16.10. Motherboard Re-Assembly

To re-assemble the motherboard, do all processes described in paragraph 12.16.9 in reverse order.

**Note:** The torque setting required for the motherboard tray backplate mounting screws (22) is 6kg-cm  
The torque setting required for the motherboard tray base mounting screws (21) is 6kg-cm

**Note:** After re-assembling the MCP9350i install the latest BIOS. See paragraph 9.2.

## 13. Software Re-installation

If the problem is not hardware related and it was also not solved by any of the software repair methods, the only option left is to re-install a software image that is known to work.

**Caution:** Performing a system re-installation will result in the loss of all user data.

1. Insert the DVD with the latest disc image (provided by Philips).
2. Reboot the MCP9350i.
3. Press 'F' for the full recovery option.
4. Press 'Y' to continue.
5. After 25 minutes the new image will have been installed.

In some cases it might be possible that the set does not boot from the DVD (although this was the default setting). In that case:

1. Reboot the MCP9350i again.
2. During the boot process, press 'F2' to enter the BIOS settings.
3. In the boot order list: add the optical drive to the top of the list.
4. Reboot again and continue with the re-installation.



## 14. End Test

Before the set can be returned to the customer an end test must be performed. Run the automatic test batch file in PC Doctor. See paragraph 10.3.

- For sets where a software and/or hardware repair has been done run the script once. The test will take approximately 15 minutes.
- For sets where no repair has been done a check must be made for intermittent faults. In PC Doctor, make sure that the script is repeated 8 times. See Figure 14-1. The test will take approximately 2 hours.

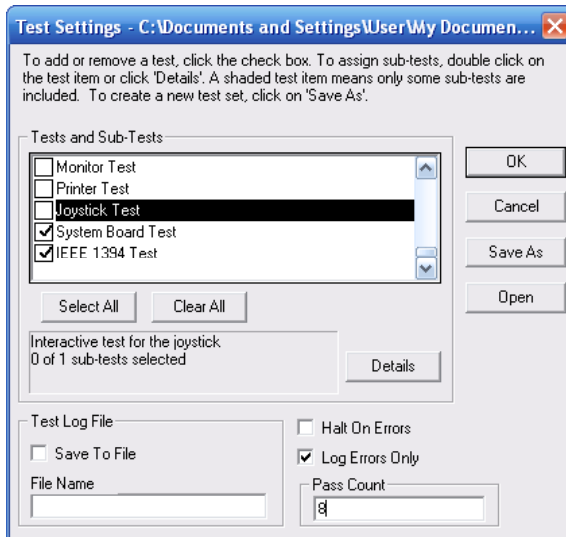
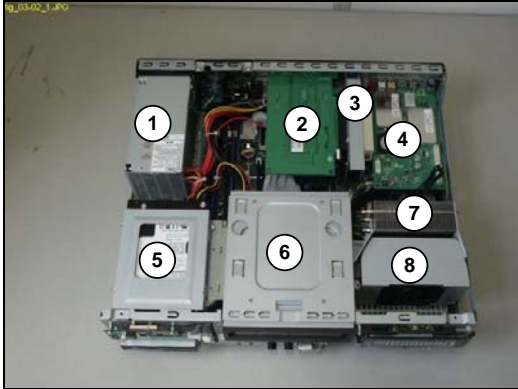

Figure 14-1

## 15. Parts Information

### 15.1. Internal Parts & Module Identification



Top View

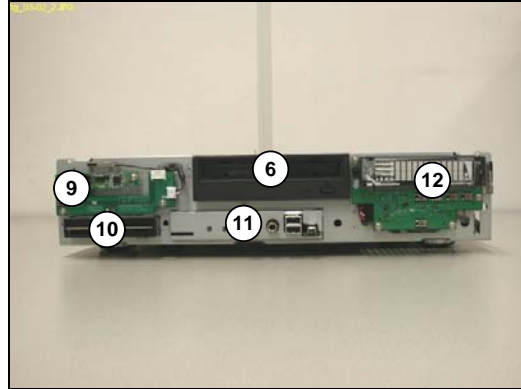

Front View

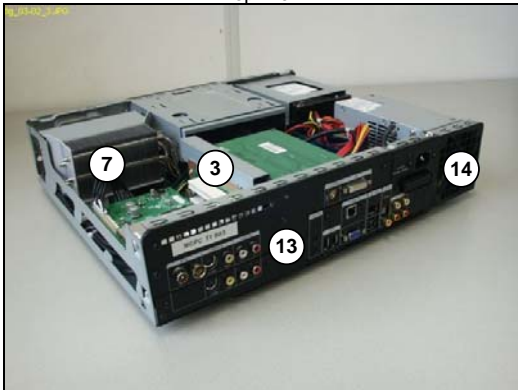

Rear-Right View

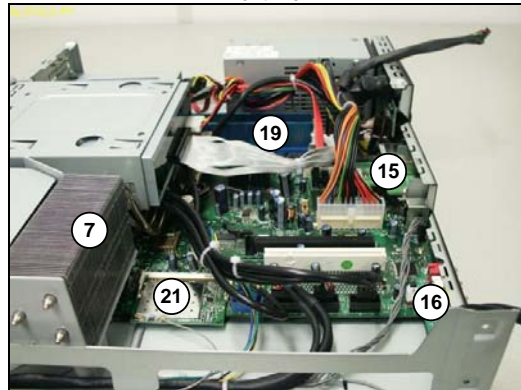

Right View

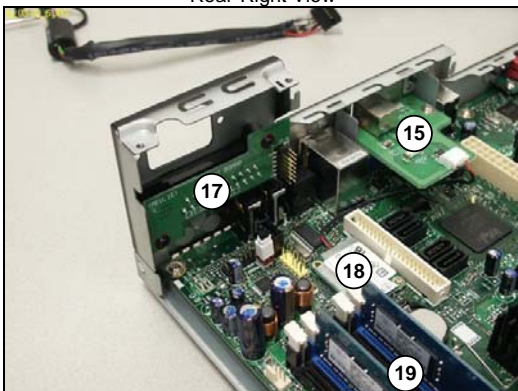

Motherboard subassembly

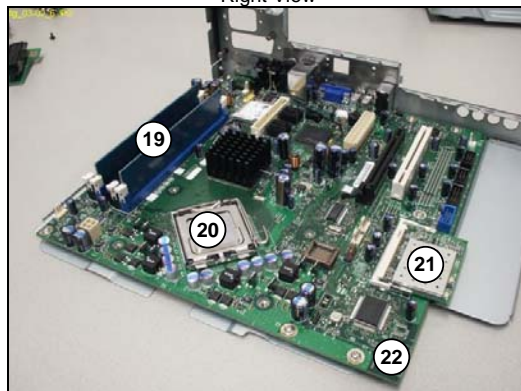

Motherboard subassembly

- |   |   |
|---|---|
| (1) Power Supply Unit (PSU)               | (12) VFD Board                          |
| (2) Graphic Card                          | (13) Backpanel                          |
| (3) Riser Card subassembly                | (14) PSU Fan                            |
| (4) TV Tuner Card                         | (15) RJ11 Connector Board subassembly   |
| (5) Hard Disk Drive (HDD) subassembly     | (16) TV Tuner Daughterboard subassembly |
| (6) Optical Disk Drive (ODD)              | (17) SCART Daughterboard                |
| (7) CPU Heat Sink                         | (18) Modem Card                         |
| (8) CPU Fan subassembly                   | (19) DIMM(s)                            |
| (9) SW & RF Board                         | (20) CPU                                |
| (10) Card Reader subassembly              | (21) WLAN Card                          |
| (11) Front Panel I/O (FP I/O) subassembly | (22) Motherboard                        |

## 15.2. Parts List

12NC	Sort	Component Type	Description	Tatung P/N
9965 000 32414	CH26	IC DIG MOS MICROPROCESSOR	LGA775 PRESCOTT 630 3.0GHZ, P4-6	5760130009
9965 000 32421	CH45	PR.CIRCUIT, COMPUTER	TV TUNER CARD PAL / NTSC	5773400058
9965 000 32436	PA29	CABLE, CONNECTING	IR BLASTER CABLE	E057301004
9965 000 32435	PA21	CABLE, CONNECTING	HDMI TO DVI-D CABLE	E057324002
9965 000 32413	CH23	HEAT SINK	LGA775 CPU COOLER (HEAT PIPE)	E732311400
9965 000 32406	CH32	FRONT, ALUMINIUM	ASM-DVD/CD /-RW-BEZEL_COLDEN (3	E733754400
9965 000 32415	CH27	IC DIG MOS MEMORY OTHERS	DDR2 533 CL 4-4-4 256MB 1.8V PB	E768102223
9965 000 32416	CH28	DISC DRIVE, HARD DISK	160GB, 8MB CACHE, 7200 RPM, SATA	E770220611
9965 000 32417	CH31	DISC DRIVE, CD-ROM	DVD-DUAL (16X), DVD8701	E770720247
9965 000 32410	CH13	PR.CIRCUIT, COMPUTER	CARD READER (8-IN-1) - PB-FREE	E771900009
9965 000 32434	PA06	REMOTE CONTROL	REMOTE CONTROL (EU)	E771900010
9965 000 32412	CH20	PR.CIRCUIT, COMPUTER	MOTHER BOARD (EU), OEMD945GSUS2(	E773001333
9965 000 32419	CH40	PR.CIRCUIT, COMPUTER	WIRELESS LAN MINI-PCI CARD, 802.	E773200069
9965 000 32418	CH34	PR.CIRCUIT, COMPUTER	ADD2 CARD SCART DAUGHTER BOARD F	E773406167
9965 000 32426	CH50	PR.CIRCUIT, COMPUTER	AZALIA SOFTWARE MODEM, MDC 1.5 IN	E773502054
9965 000 32427	CH52	PR.CIRCUIT, COMPUTER	VFD BOARD - PB-FREE	E773700110
9965 000 32411	CH15	PR.CIRCUIT, COMPUTER	FRONT PANEL I/O BOARD - PB-FREE	E773700111
9965 000 32431	CH61	PR.CIRCUIT, COMPUTER	POWER SWITCH BOARD - PB-FREE	E773700112
9965 000 32424	CH47	PR.CIRCUIT, COMPUTER	MODEM DAUGHTER BOARD (PB-FREE)	E773700113
9965 000 32420	CH41	AERIAL	WIRELESS LAN ANTENNA, BLACK/GRAY	E773700123
9965 000 32423	C452	CABLE, CONNECTING	10-PIN CONNECTOR CABLE	E773700125
9965 000 32422	C451	PR.CIRCUIT, COMPUTER	DAUGHTER BOARD	E773700128
9965 000 32407	CH02	POWER SUPPLY UNIT	HEPS, 275W	E775104001
9965 000 32409	CH24	FAN, ELECTRIC	COOLING FAN, 12V/4500RPM, 4PIN,L=	E776213001
9965 000 32408	CH03	FAN, ELECTRIC	COOLING PSU FAN, 12V/4500RPM, 4PI	E776213002
9965 000 32425	CH48	CABLE, CONNECTING	MD CABLE (RJ11 CABLE)	E784004002
9965 000 32429	CH54	CABLE, CONNECTING	IR BLASTER INTERNAL_CABLE	E784006002
9965 000 32430	CH55	CABLE, CONNECTING	SW_RF_CABLE	E784006003
9965 000 32432	CH62	CABLE, CONNECTING	V-TYPE_CABLE	E784010006
9965 000 32428	CH53	CABLE, CONNECTING	VFD_USB_CABLE	E784014001
MPC9350I/03			MPC9350I/03 NL (KEYBORD QWERTY VS)	
9965 000 32383	PA05	KEYBOARD	USB WIRELESS KEYBOARD (NETHERLANDS)	E771100290
MPC9350I/05			MPC9350I/05 UK (KEYBORD QWERTY UK)	
9965 000 32381	PA02	KEYBOARD	USB WIRELESS KEYBOARD (PHILIPS)	E771100286
MPC9350I/19			MPC9350I/19 FR (KEYBOARD AZERTY)	
9965 000 32380	PA03	KEYBOARD	USB WIRELESS KEYBOARD (FRENCH)	E771100292
MPC9350I/02			MPC9350I/02 GE (KEYBOARD QWERTZ)	
9965 000 32433	PA04	KEYBOARD	USB WIRELESS KEYBOARD (GERMANY)	E771100291

### 15.3. After replacement

All faulty cables and modules must be stored by the service center for a minimum of two months. In that period Philips has the opportunity to ask for shipment to a central location for further analysis. After that period the faulty items may be disposed of in an appropriate manner.

